



UNITED NATIONS
INDUSTRIAL DEVELOPMENT ORGANIZATION



Technology Compendium for Energy Efficiency and Renewable Energy Opportunities in Ceramic Sector

Morbi Ceramic Cluster



UNITED NATIONS INDUSTRIAL DEVELOPMENT ORGANIZATION

September 2020



Disclaimer

This document is prepared to provide overall guidance for conserving energy and costs. It is an output of a research exercise undertaken by Confederation of Indian Industry (CII) supported by the United Nations Industrial Development Organization (UNIDO) and Bureau of Energy Efficiency (BEE) for the benefit of the ***Ceramic Industry located at Morbi, Gujarat, India***. The contents and views expressed in this document are those of the contributors and do not necessarily reflect the views of CII, BEE or UNIDO, its Secretariat, its Offices in India and elsewhere, or any of its Member States.

Promoting Energy Efficiency and Renewable Energy in Selected MSME Clusters in India

(A GEF funded project being jointly implemented by UNIDO & BEE)



UNITED NATIONS
INDUSTRIAL DEVELOPMENT ORGANIZATION



Compendium of Energy Efficiency and Renewable Energy Technologies for Morbi Ceramic Cluster

September 2020

Developed under the assignment

Scaling up and expanding of project activities in MSME Clusters

Prepared by



Confederation of Indian Industry
125 Years - Since 1895

CII Sohrabji Godrej Green Business Centre
Survey No.64, Kothaguda Post, R R District,
Hyderabad, Telangana 500084
INDIA





Acknowledgement



Acknowledgement

This assignment was undertaken by Confederation of Indian Industry (CII) as a project management consultant under the Global Environment Facility (GEF) funded project ‘Promoting Energy Efficiency and Renewable Energy in selected MSME clusters in India.’ The Technology Compendiums are meant to serve as an informative guide to the clusters that the project is currently working in and also to the other potential clusters across the country.

CII would like to express its gratitude to United Nations Industrial Development Organization (UNIDO) and Bureau of Energy Efficiency (BEE) for having provided the guidance in the completion of this assignment.

CII would like to specially thank all the professionals for their valuable contributions in finalizing the different technology compendiums developed under the assignment. CII is grateful to Mr. Abhay Bakre, Director General, BEE, Mr R K Rai, Secretary, BEE and Mr. Milind Deore, Director, BEE for their support and guidance during the assignment. CII would like to express its appreciation to Mr. Sanjaya Shrestha, Industrial Development Officer, Energy Systems and Infrastructure Division, UNIDO, for his support in execution of the assignment. We would like to thank Mr. Suresh Kennit, National Project Manager, and the entire Project Management Unit (PMU) for their timely coordination and valuable inputs during the assignment.

CII would like to take this opportunity to thank all the MSME unit owners, local service providers and equipment suppliers for their active involvement and valuable inputs in the development of the technology compendiums. We extend our appreciation to the different Industry Associations in the clusters for their continuous support and motivation throughout the assignment.

Finally, we would like to thank each and every personnel from CII team who have been actively involved at every step of the compilation and whose tireless and valuable efforts made this publication possible.

CII Team



Table of Contents

List of Figures	8
List of Tables	10
List of Abbreviations	13
Unit of Measurement	15
About the Project	17
About the Technology Compendium	19
Executive Summary	23
1. Indian Ceramic Industry	27
1.1. Background	27
1.2. Ceramic Sector Growth Prospects	29
1.3. Morbi Ceramic Cluster	30
2. Manufacturing Process and Energy consumption	33
2.1. Ceramic Product Value Chain	33
2.2. Process Flow for Tile and Sanitaryware Manufacturing	35
2.3. Energy Consumption in Ceramic tiles & Sanitaryware Manufacturing Units	41
2.4. Technology Status in Morbi Ceramic Cluster	43
2.5. Benchmarking	45
3. Energy Efficiency Opportunities	49
3.1. Energy Efficiency in Ceramic Tile and Sanitaryware Units	49
3.2. Energy Efficiency Measures	50
3.2.1. Energy Efficiency in Roller & Tunnel Kiln Firing	51
3.2.2. Energy Efficiency in Raw Material Preparation Process	52
3.2.3. Energy Efficiency in Utilities	53
4. Energy Efficient Technologies — Case Studies	55
4.1. Case Studies in Kiln	57
4.1.1. Waste Heat Recovery in Roller kiln	57
4.1.2. Waste Heat Recovery in Tunnel Kiln	61
4.1.3. Energy Efficient Coating Inside Kiln to Reduce the Radiation Losses in Kiln and Reduce Fuel Consumption	64
4.1.4. Low Thermal Mass for Reduction of Kiln Car Losses in Sanitaryware Units	67
4.1.5. Improvement of Kiln Insulation in Roller Kiln to Reduce Radiation Losses	71
4.1.6. Excess Air Control System to Maintain Optimum Air to Fuel Ratio in Kiln	74
4.2. Case Studies in Raw Material Blending	77
4.2.1. Reduction in Ball Mill Power by Installation of VFD on Ball Mill Drive	77
4.2.2. High Speed Blunger in Place of Ball Mill for Raw Material Grinding Process	79
4.2.3. High Alumina Media in Glaze Ball Mill in the Place Natural Stone/Pebble	82
4.2.4. Replacement of Inefficient Centrifugal Fans with Energy Efficient Fans in Spray Dryer	85



4.3. Case Studies in Utilities	88
4.3.1. Installation of VFD in Screw Compressor to Avoid Unloading	88
4.3.2. Installation Screw Compressor with VFD in Place of Reciprocating Compressor	91
4.3.3. Energy Conservation in Compressor by Modifying Airline System	94
4.3.4. Retrofit of Energy Efficient Ceiling Fans in Place of Conventional Fans	97
4.3.5. Installation of Energy Efficient Pump	100
4.3.6. Installation of Energy Efficient Motors in Place of Old Rewinded Motors	103
4.3.7. Transvector Nozzle for Compressed Air Sanitaryware Mould Cleaning Application	107
4.3.8. Maximum Demand Controller for Avoiding Excess Contract Demand Penalty.....	110
4.3.9. Power Factor Correction & Harmonic Mitigation at Main LT Incomer	113
4.3.10. Installation of VFD on Agitator Motor	116
4.3.11. Installation of On-off Controller System in Agitator Motor	118
4.3.12. Installation of Energy Efficient Motor in Place of Existing Conventional Motors in Agitator System.....	120
4.4. Case Studies in Renewable Energy	123
4.4.1. Solar Rooftop System.....	123
4.5. New and Innovative Technologies	128
4.5.1. Solar-Wind Hybrid System	128
4.5.2. Implementation of CFD Analysis for Improving Heat Transfer in Spray Dryer	132
4.5.3. Hydroxy Gas Combustion in Kiln Firing in Roller Kiln	136
4.5.4. Installation of Energy Efficient burners in place of existing old conventional burners in kiln firing	138
4.5.5. Optimization of water consumption by installation of water softener unit	141
4.5.6. Installation of Energy Management System	144
4.5.7. Insulation improvement in Hot air generator for spray dryer.....	147
4.5.8. Excess air control system to maintain optimum air to fuel ratio in Hot air generator (HAG).....	150
5. Conclusion	153



List of Figures

Figure 1: Ceramic Product Market Share (2017).....	27
Figure 2: Ceramic units footprint in Morbi cluster.....	30
Figure 3: Ceramic product manufacturing process value chain.....	33
Figure 4: Ceramic Tile Manufacturing Process Flow.....	35
Figure 5: Raw Material Blending (Wet ball milling).....	35
Figure 6: Slip agitation and storage	36
Figure 7: Spray Drying process	36
Figure 8: Pressing Machine	36
Figure 9: Tiles Drying.....	36
Figure 10: Glazing	37
Figure 11: Roller Kiln firing.....	37
Figure 12: Firing Cycle	37
Figure 13: Ceramic Sanitaryware Manufacturing Process Flow.....	38
Figure 14: Raw Material Blending (Wet ball milling).....	38
Figure 15: Slip agitation and storage	38
Figure 16: Mould Preparation	39
Figure 17: Cast House.....	39
Figure 18: Glazing	39
Figure 19: Tunnel Kiln firing	39
Figure 20: Firing Cycle.....	40
Figure 21: Energy Cost Breakup	41
Figure 22: Energy Balance in Ceramic Tile Manufacturing Unit.....	42
Figure 23: Energy Balance of a Sanitaryware Unit.....	42
Figure 24: Energy Efficiency Approach – Morbi Ceramic unit.....	49
Figure 25: Ceramic tile manufacturing unit – Energy usage area.....	50
Figure 26: Sanitary ware manufacturing unit – Energy usage area.....	50
Figure 27: Before implementation – Exhaust chimney at 250°C.....	57
Figure 28: After Implementation – Exhaust shifted to 200°C temperature zone.....	58
Figure 29: Reduction of SEC after Implementation.....	58
Figure 30: Use of hot air as combustion air	61
Figure 31: Various zones in Kiln	64
Figure 32: Surface temperature at firing zone in a kiln	64
Figure 33: Existing high thermal mass refractory in kiln car.....	67
Figure 34: Low thermal mass in kiln car	67
Figure 35: Firing Cycle	71
Figure 36: Thermal Image of Roller Kiln	71
Figure 37: Quantity of Heat loss from Surface vs temperature	72

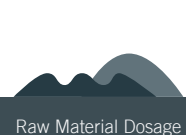
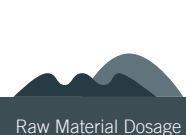

Figure 38: PID & VFD based Excess air control system	75
Figure 39: Conventional ball mill system.....	79
Figure 40: High Speed Turbo Blunger.....	80
Figure 41: Mined Stone Pebble	82
Figure 42: High Alumina Ball	82
Figure 43: Typical characteristic curve of centrifugal fan	85
Figure 44: Capacity control of compressor.....	89
Figure 45: Reciprocating Compressor.....	91
Figure 46: Existing compressed air piping.....	94
Figure 47: HDPE Aluminium Pipe-line.....	94
Figure 48: % loading for Energy Efficient Motors	103
Figure 49: Energy Efficient Motors	104
Figure 50: Transvector Nozzle	107
Figure 51: Demand variation with and without demand control	111
Figure 52: Operation of hybrid filter	113
Figure 53: Connection Diagram.....	114
Figure 54: Reduction in KVA with & Without operation of Hybrid Filter	114
Figure 55: % loading for Energy Efficient Motors.....	120
Figure 56: Energy Efficient Motors.....	121
Figure 57: Solar Irradiance.....	123
Figure 58: Solar wind hybrid system	128
Figure 59: Hybrid mill connected to supply	129
Figure 60: Hybrid mill connected to loads.....	129
Figure 61: Spray Drying Process	132
Figure 62: Particle flow pattern and velocity distribution inside the chamber	133
Figure 63: CFD Model of main drying chamber	133
Figure 64: Contours of moisture concentration and temperature distribution inside the chamber	133
Figure 65: HHO Gas Generator	136
Figure 66: High velocity burner.....	138
Figure 67: High Velocity Burner with Flame.....	138
Figure 68: Perfect combustion with correct air fuel to ratio	139
Figure 69: Improper air to fuel ratio	139
Figure 70: Water softener unit	141
Figure 71: Components of Energy Management System	144
Figure 72: Spray dryer system.....	147
Figure 73: Thermal images of Hot gas generator duct connecting to cyclone separator.....	147
Figure 74: Spray dryer system.....	150



List of Tables

Table 1: List of Technologies	24
Table 2: Top 5 Ceramic Tile Manufacturing Countries of the world (in MSM)	27
Table 3: Cluster Level Details.....	28
Table 4: Energy Consumption Overview for Ceramic Tile Unit	41
Table 5: Energy Consumption Overview for Sanitaryware Unit.....	41
Table 6: Technology Status – Morbi Ceramic Cluster.....	43
Table 7: Product wise specific energy consumption for units in Morbi cluster.....	45
Table 8: Industry benchmark for Indian Ceramic Products	45
Table 9: Equipment wise specific energy consumption – Sanitaryware unit.....	46
Table 10: Equipment wise specific energy consumption – Floor tile unit.....	46
Table 11: Equipment wise specific energy consumption – Wall tile unit	47
Table 12: Equipment wise specific energy consumption – Vitrified tile unit	47
Table 13: Energy efficiency measures in kiln.....	51
Table 14: Energy efficiency in raw material preparation process.....	52
Table 15: Energy efficiency in utilities	53
Table 16: Case Studies for Morbi ceramic cluster.....	55
Table 17: Cost benefit analysis – WHR in kiln.....	59
Table 18: Technology supplier for Waste Heat Recovery	60
Table 19: Cost Benefit Analysis – Waste Heat Recovery	62
Table 20: Technology Supplier Details – Waste Heat Recovery	63
Table 21: Zone wise average surface temperature in Kiln	64
Table 22: After Implementation Zone wise temperature.....	65
Table 23: Cost benefit analysis – Energy efficient coating	65
Table 24: Technology Supplier Details – Energy efficient coating	66
Table 25: Cost benefit analysis – Low thermal mass in kiln car.....	68
Table 26: Technology supplier details – Low thermal mass.....	69
Table 27: Low thermal mass – Morbi cluster reference.....	69
Table 28: Low thermal mass – Thangadh Cluster Reference	70
Table 29: Low thermal mass – Naroda Cluster Reference	70
Table 30: Cost benefit analysis for Kiln insulation Improvement	72
Table 31: Technology supplier – Kiln insulation	73
Table 32: Flue gas analysis & excess air in one of the kiln.....	74
Table 33: Cost benefit analysis for optimising excess air in the kiln.....	75
Table 34: Technology Supplier Details – Air and Gas Flow Control System	76
Table 35: Cost benefit analysis VFD in ball mill	77
Table 36: Technology supplier details for VFD	78

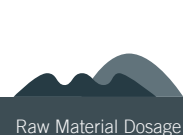

Table 37: Cost benefit analysis – High speed blunger.....	80
Table 38: Technology supplier details – High speed blunger.....	81
Table 39: Cost benefit analysis – High Alumina ball/Lining Grinding.....	83
Table 40: Technology Supplier Details – High alumina grinding balls.....	84
Table 41: Operating parameters of existing fans.....	86
Table 42: Cost Benefit Analysis - Energy efficient centrifugal fans	86
Table 43: Technology supplier details – Energy efficient centrifugal fans.....	87
Table 44: Compressor loading pattern	88
Table 45: Cost Benefit Analysis.....	89
Table 46: Technology Supplier Details – VFD for air compressor.....	90
Table 47: Cost Benefit Analysis – Screw compressor in place of reciprocating compressor..	92
Table 48: Technology supplier details – Screw air compressor.....	93
Table 49: Cost benefit analysis – Aluminum pipe for compressed air	95
Table 50: Technology Supplier Details – HDPE Aluminium Piping.....	96
Table 51: Cost benefit analysis – Energy efficient BLDC ceiling fan	98
Table 52: Technology Supplier Details – Energy efficient BLDC fan	99
Table 53: Comparison between conventional pump set and S4RM pump	100
Table 54: Cost Benefits Analysis – EE Pumps.....	101
Table 55: Technology Supplier Details – EE pumps	102
Table 56: Cost Benefit analysis EE Motors	105
Table 57: Technology Suppliers for EE Motors.....	106
Table 58: Cost Benefit Analysis – Transvector Nozzle.....	108
Table 59: Technology Supplier Details – Transvector Nozzle	109
Table 60: Cost Benefit Analysis – Maximum Demand Controller.....	111
Table 61: Technology Supplier for Maximum Demand Controller	112
Table 62: Cost Benefit Analysis – power factor improvement	115
Table 63: Technology supplier details - Hybrid filter for power factor improvement.....	115
Table 64: Cost benefit analysis – VFD in agitator motor	116
Table 65: Technology Supplier details for VFD	117
Table 66: Cost Benefit analysis - On off controller system in agitation system	118
Table 67: Technology supplier details for on-off controller system.....	119
Table 68: Cost Benefit analysis - Energy efficient motors in agitation system	121
Table 69: Technology supplier details for on-off controller system	122
Table 70: Site Specification – For Solar PV	123
Table 71: Features/requirements for Grid Connected Solar PV Systems (Rooftop)	124
Table 72: Cost Benefit Analysis – Solar PV Systems	126
Table 73: Technology Supplier Details for Solar Rooftop System.....	127
Table 74: Cost Benefit Analysis – Solar Wind Hybrid Systems.....	130

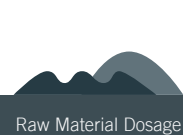

Table 75: Technology Supplier Details – Solar-Wind Hybrid Systems	131
Table 76: Cost benefit analysis – CFD on Spray dryer	134
Table 77: Technology Supplier Details – CFD Analysis.....	135
Table 78: Cost Benefit Analysis for Hydroxy Gas Combustion System in Kiln Firing	137
Table 79: Technology Supplier Details – Hydroxy Gas Generator System.....	137
Table 80: Cost benefit analysis – Energy efficient burner.....	140
Table 81: Technology supplier details – Energy Efficient Burner	140
Table 82: Cost benefit analysis – Improved water quality in ball mill.....	142
Table 83: Supplier details – Industrial water softener.....	143
Table 84: Cost benefit analysis – Energy Management System.....	145
Table 85: Technology supplier details – Energy Management System.....	146
Table 86: Cost benefit analysis – Insulation improvement in HAG for spray dryer	148
Table 87: Technology supplier details – Insulation improvement in HAG	149
Table 88: Cost benefit analysis – Excess air control system in HAG	151
Table 89: Technology supplier details – Excess air control system	152



List of Abbreviations

AC	Alternating Current
APFC	Automatic Power Factor Controller
BEE	Bureau of Energy Efficiency
BLDC	Brushless Direct Current
CAGR	Compound Annual Growth Rate
CFD	Computational Fluid Dynamics
CII	Confederation of Indian Industry
DC	Direct Current
DPR	Detailed Project Report
EE	Energy Efficient
EUR	Euro
GCRT	Grid Connected Roof top
GCV	Gross Calorific Value
GEF	Global Environment Facility
GHG	Greenhouse Gas
GI	Galvanized Iron
HDPE	High Density Poly Ethylene
HHO	Hydroxy gas
INR	Indian Rupee
IoT	Internet of Things
ISO	International Standards Organization
LED	Light Emitting Diode
LSP	Local Service Provider
LT	Low Tension
MNRE	Ministry of New and Renewable Energy
mn	million
MPPT	Maximum Power Point Tracker
MSM	Million Square Metre
MSME	Micro, Small and Medium Enterprises
NG	Natural Gas



NGT	National Green Tribunal
O&M	Operation and Maintenance
OEM	Original Equipment Manufacturer
PCU	Power Conditioning Unit
PF	Power Factor
PID	Proportional Integral Derivative
PLC	Programmable Logic Controller
PMU	Project Management Unit
PNG	Piped Natural Gas
PV	Photovoltaic
RE	Renewable Energy
SEC	Specific Energy Consumption
SME	Small and Medium Enterprise
SPV	Solar Photo Voltaic
TOE	Tonne of Oil Equivalent
TDS	Total Dissolved Solids
UNIDO	United Nations Industrial Development Organisation
UOM	Unit of Measurement
VFD	Variable Frequency Drive
WHR	Waste Heat Recovery



Raw Material Dosage

Body Preparation

Tile Pressing

Drying

Glazing

Printing

Firing

Final Output

Unit of Measurement

CFM	Cubic Feet per Minute
°C	Degree Celsius
GJ	Giga Joule
hp	Horsepower
INR	Indian Rupee
kg	Kilogram
kg/cm ²	Kilogram Force per Square Centimetre
kCal	Kilocalorie
kJ	kilo Joule
km	Kilometre
kVA	kilo-volt-ampere (apparent power)
kVA _r	kilovolt-ampere-reactive (reactive power)
kW	Kilo Watt
kWh	Kilo Watt Hour
kWp	Kilo Watt Peak
LPM	Litre per minute
m	Metre
m ²	Square metre
MJ	Mega Joule
MT	Metric Tonne
mmWc	Millimetre water column
m ³ /hr	Cubic metre per hour
m ³ /min	Cubic metre per minute
m/s	Metre per second
ppm	Parts per million
SCM	Standard Cubic Metre
TCO ₂	Tonne of Carbon dioxide
TOE	Tonne of Oil Equivalent
TPD	Tonne Per Day

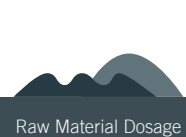

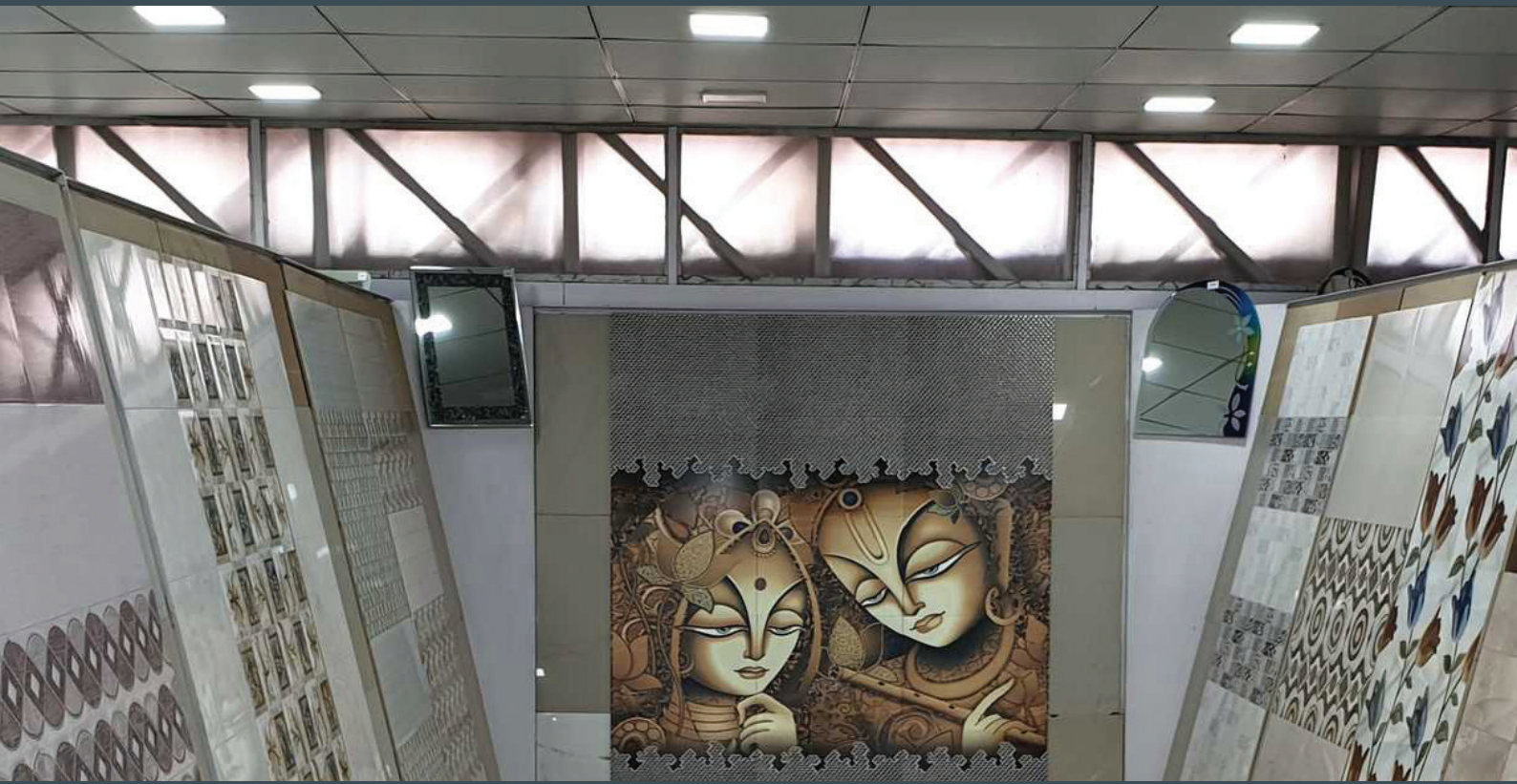

About Project & Technology Compendium



About the Project

The United Nations Industrial Development Organization (UNIDO), in collaboration with the Bureau of Energy Efficiency (BEE), a statutory body under the Ministry of Power, Government of India, is executing a Global Environment Facility (GEF) funded national project titled ‘Promoting energy efficiency and renewable energy in selected MSME clusters in India’. The project was operational in 12 MSME clusters across India in five sectors, respectively: Brass (Jamnagar); Ceramics (Khurja, Thangadh and Morbi); Dairy (Gujarat, Sikkim and Kerala); Foundry (Belgaum, Coimbatore and Indore); Hand Tools (Jalandhar and Nagaur). The Project has now scaled-up and expanded its activities to 11 new clusters, namely in Dairy (Tamil Nadu, Odisha, Madhya Pradesh, Andhra Pradesh & Telangana, Haryana, Maharashtra & Punjab), Foundry (Ahmedabad & Howrah), Ceramic (Himmatnagar) Mixed Cluster (Indore & Sikkim) in order to reach out to MSME’s at national level.

This project so far has supported 303 MSME units in implementing 603 Energy conservation Measures and thus resulted in reduction of about 10,850 TOE energy consumption and avoided 62,868 metric tons of CO₂ emissions as on date.

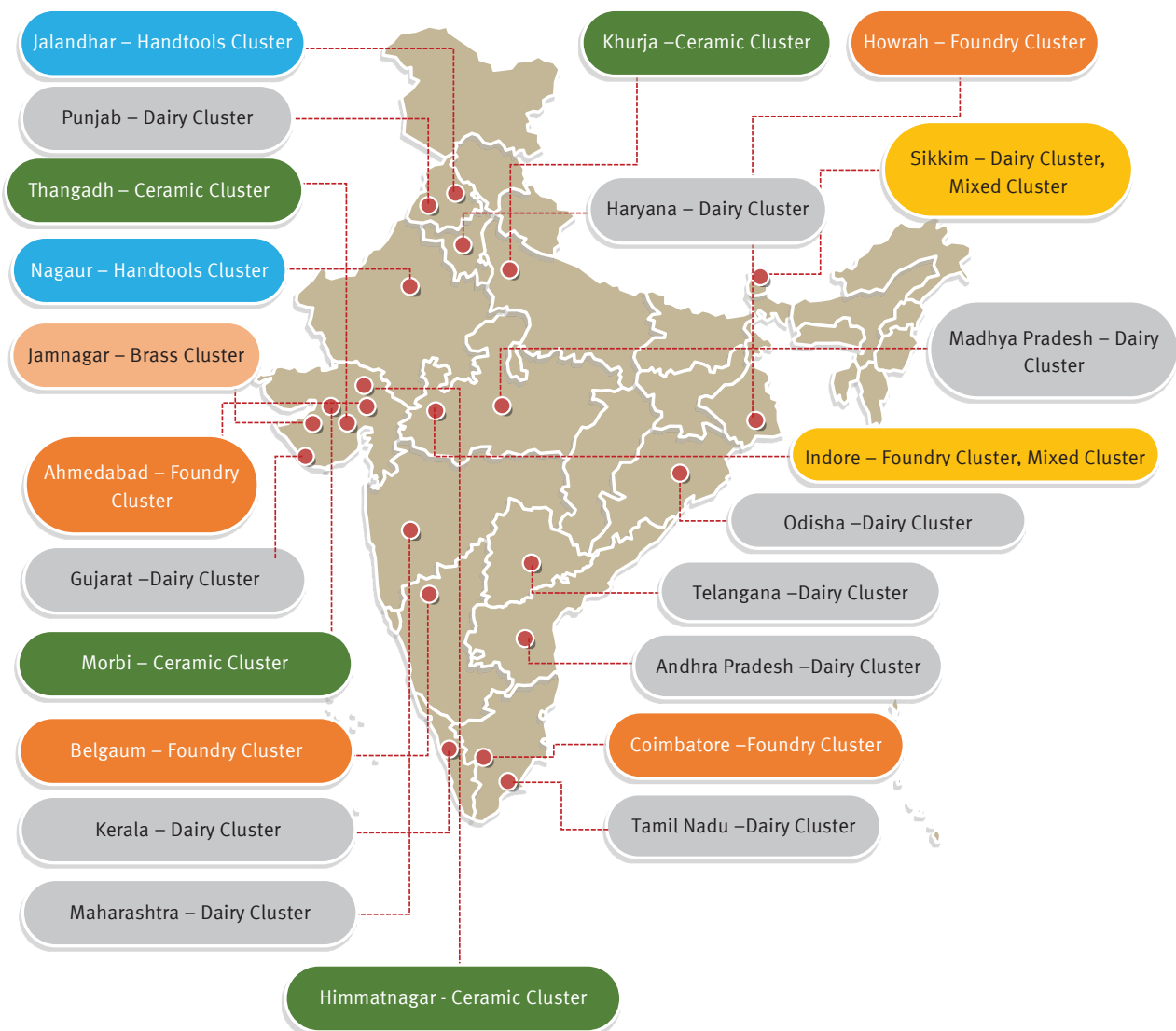

The key components of the project include:

- ❖ Increasing capacity of suppliers of EE/RE product suppliers / service providers / finance providers
- ❖ Increasing the level of end user demand and implementation of EE and RE technologies and practices by MSMEs.
- ❖ Scaling up of the project to more clusters across India.
- ❖ Strengthening policy, institutional and decision-making frameworks.
- ❖ Significant progress has been made in the project and it is now proposed to scale up and expand. The activities envisaged under the scaling up phase of the project include:
 - ✧ Establishment of field level Project Management Cell (PMC)
 - ✧ Organizing cluster level awareness program and identification of potential MSME enterprises
 - ✧ Development of cluster specific EE and RE based technology compendiums
 - ✧ Providing implementation support and other related activities to the identified enterprises



About the Technology Compendium

The ceramic industry in India is about 100 years old. It comprises ceramic tiles, sanitaryware and crockery items. Ceramic products are manufactured both in the large and small scale sectors, with wide variation in type, size, quality and standard. Though there are a number of large companies in the ceramics sector, small and medium enterprises (SMEs) account for more than 50% of the total market in India.

The SME players in the ceramic sector today face challenges and opportunities resulting from rising energy costs, environmental concerns and competitiveness. The increase in the price of raw materials and fuel drives up the total cost of production, which in turn hampers the profit margin of the manufacturers. The energy cost accounts for 30 to 40% of total production cost. Adopting energy efficient equipment, systems, measures and best practices could offers substantial cost savings and improvement in profit margins.

This technology compendium is prepared with the objective of accelerating adoption of energy efficient technologies and practices in ceramic units in Morbi cluster. It focuses on equipment upgrades, new technologies and best practices for improving energy efficiency. The case studies included in the compendium provide all the necessary information to enable ceramic units implement them in their operations. The case studies are supported with technology background, baseline scenario, merits, challenges, technical feasibility, financial feasibility and technology provider details. The energy efficiency measures included in the report cover more than 90% of energy consumption in a ceramic unit.

The thermal energy accounts for 80 to 90% of the total energy consumption. Roller kiln in tiles manufacturing units and tunnel kilns in sanitaryware units are the major source of fuel consumption. The electricity is mainly used for raw material preparation (ball mills drive, slurry transfer pumps, spray dryer fans, etc.), blowers in kiln, pumps and compressors. Over the years, there has been significant technological improvement in the process and utilities area and the ceramic units in Morbi have been able to improve the energy efficiency in their operations. However, various opportunities still exist for improvement in energy efficiency. To be competitive and have environment friendly operations, energy efficiency is critical.

- ❖ The objective of this compendium is to act as a catalyst to facilitate ceramic units towards continuously improving energy performance, thereby achieving world class levels (with a thrust on energy & environmental management).
- ❖ The compendium includes general energy efficiency options as well specific case studies on applicable technology upgradation project which can result in significant energy efficiency improvements.
- ❖ The suggested best practices may be considered for implementation only after detailed evaluation and fine-tuning requirements of existing units.
- ❖ In the wide spectrum of technologies and equipment applicable for tiles and sanitaryware manufacturing units for energy efficiency, it is difficult to include all the energy conservation aspects in this manual. However, an attempt has been made to include the more common



implementable technologies across all the ceramic units.

- ❖ The user of the compendium has to fine-tune energy efficiency measures suggested in the compendium to their specific unit requirements, to achieve maximum benefits.
- ❖ The technologies collated in the compendium may not be necessarily the ultimate solution as the energy efficiency through technology upgradation is continuous process and will eventually move towards better efficiency with advancement in technology.
- ❖ The ceramic industry in Morbi should view this manual positively and utilize this opportunity to implement the best operating practices and energy saving ideas during design and operations stages and thus work towards achieving world class energy efficiency.



This Page Intentionally Left Blank





Executive Summary



Executive Summary

The United Nations Industrial Development Organization (UNIDO), in collaboration with the Bureau of Energy Efficiency (BEE), a statutory body under the Ministry of Power, Government of India, is executing a Global Environment Facility (GEF) funded national project called ‘Promoting energy efficiency and renewable energy in selected MSME clusters in India’. The project execution is planned in multiple phases. The aim of the Phase-I of the project was to develop and promote a market environment for introducing energy efficiency and enhanced use of renewable energy technologies in process applications in the selected (12) energy-intensive MSME clusters in India, with feasibility for expansion to more clusters. Phase-II of the project is to scale up and expand the project activities to a greater number of enterprises in existing clusters, as well as 11 new clusters, for better implementation of energy efficiency technologies and practices.

Efficient use of energy in any facility is invariably the most important strategic area for manageability of cost or potential cost savings. Awareness of the personnel, especially operators in the facility, becomes a significant factor for the proper implementation of energy conservation initiatives. With this context, this Technology Compendium has been prepared, which comprises of various technologies and best practices to save energy.

The information in this compendium is intended to help the ceramic units in Morbi ceramic cluster reduce energy consumption in a cost-effective manner while maintaining the quality of products manufactured. Further analysis on the economics of all measures as well as on their applicability to different production practices is needed to assess their cost effectiveness at individual ceramic units. Further, this shall also serve as a guide for estimating the feasibility of energy saving project at the first place and ensure accelerated implementation.

Chapter 1 of the compendium provides an overview of Indian Ceramic Industry.

Chapter 2 focuses on a brief overview of the tiles and sanitaryware manufacturing process and energy consumption in ceramic units and also includes technology status/mapping of the Morbi ceramic cluster.

Chapter 3 focuses on the importance of energy efficiency in ceramic industry and some of the common measures applicable in different sections of the ceramic unit. The energy efficiency measures are included for more than 90% of energy consumption areas in a tile and sanitaryware manufacturing unit, such as raw material preparation, press machine, mould preparation, slip/slurry transfer, spray dryer, kiln, utilities and utilization of renewable energy. The chapter also includes some of the best practices on energy efficiency.

Chapter 4 provides detailed case studies for some of high impact and implementable energy efficient technologies in tile and sanitaryware manufacturing units. In this chapter, 31 case studies have been included in areas such as raw material preparation, press machine, mould preparation, slip/slurry transfer, spray dryer, kiln, utilities and utilization of renewable energy etc. These technologies are described in detail, such as baseline scenario, proposed scenario, merits, demerits, etc. and wherever possible, a case reference from a ceramic unit that has implemented the technology has been included. In most of the examples, typical



energy saving data, GHG emission reduction, investments, payback period, etc., have been highlighted. Energy saving potential in this sector is estimated to be about 10-15%. High potential for improving energy efficiency in tile and sanitaryware units exists in the kilns via installation of high velocity kiln burner, excess air control system in kiln, waste heat recovery in roller & tunnel kiln, reduction in kiln radiation losses, low thermal mass kiln cars, blunger in place of ball mill, high alumina balls in glaze ball mills, installation of energy efficient pumps and blowers and solar PV, etc.

The following table summarizes the list of technologies included in the compendium:

Table 1: List of Technologies

Sr. No.	Technologies	Investment (INR Lakh/TOE)	Payback (months)
Kiln			
1	Waste Heat recovery in Roller Kiln	0.084	3
2	Waste Heat recovery in tunnel kiln	0.36	13
3	Energy efficient coating to reduce the radiation losses in kiln and reduce fuel consumption	0.32	12
4	Low thermal mass for reduction of kiln car losses in sanitaryware units	0.36	13
5	Improvement of kiln insulation to reduce radiation losses	0.32	15
6	Excess air control system to maintain optimum air-to- fuel ratio in Kiln	0.71	26
Raw Material Blending			
7	Reduction in ball mill power by installation of VFD on ball mill drive	0.66	10
8	High speed blunger in place of ball mill	1.40	24
9	High alumina media in glaze ball mill in the place natural stone/ pebbles	1.55	23
10	Replacement of inefficient centrifugal fans with energy efficient fans in spray dryer	0.317	6
Utilities			
11	Installation of VFD in screw compressor to avoid unloading	0.63	11
12	Installation screw compressor with VFD in place of inefficient reciprocating compressor	1.86	29
13	Energy conservation in compressor by modifying airline system	1.09	15
14	Installation of energy efficient ceiling fans in place of conventional fans.	1.08	16
15	Installation of energy efficient pumps	0.52	28
16	Transvector nozzle in compressed air hose pipe for mould cleaning application	0.85	12



Sr. No.	Technologies	Investment (INR Lakh/TOE)	Payback (months)
17	Installation of energy efficient motors in place of old rewinded motors in ball mill	0.62	8
18	Maximum demand controller for avoiding excess contract demand penalty	--	12
19	Power factor correction & harmonic mitigation at main LT incomer	--	11
20	Installation of VFD on agitator motor	0.61	9
21	Installation of on-off controller system in agitator motor	0.12	2
22	Installation of energy efficient motor in place of existing conventional motors in agitator system	1.25	18
Renewable Energy			
23	Solar rooftop system	2.68	40
New & Innovative technologies			
24	Solar-Wind hybrid system	5.30	84
25	CFD application in spray dryer for improving heat transfer	0.148	16
26	Energy efficiency in ceramic kiln through utilization of HHO Gas	0.77	28
27	Installation of Energy Efficient burners in place existing old conventional burner in kiln firing	0.82	30
28	Optimization of water consumption by installation of water softener unit	0.27	26
29	Installation of Energy Management System	0.086	3
30	Insulation improvement in Hot air generator for spray dryer	0.254	21
31	Excess air control system to maintain optimum air to fuel ratio in Hot air generator (HAG)	0.0611	5





Indian Ceramic Industry



1. Indian Ceramic Industry

1.1. Background

The Indian ceramic industry contributes considerably to India's economic progress. With growing urbanization and increasing use of ceramic tiles and sanitary ware in the Indian construction sector, the industry is expected to grow further at an increased rate. Indian ceramic industry is dominated by ceramic tiles industry. In 2017, India strengthened its position as the world's 2nd largest tile producer and consumer country, accounting for 7.97% (1,080 million sq m)¹ of the global production. Though there are a number of large companies in the ceramics sector, small and medium enterprises (SMEs) account for more than 50% of the total market in India. Gujarat accounts for 70% of the total output.

Table 2: Top 5 Ceramic Tile Manufacturing Countries of the world (in MSM)

Country	2015	2016	2017	% of world production in 2017
China	5,970	6,495	6,400	47.23
India	850	955	1,080	7.97
Brazil	899	792	790	5.83
Vietnam	440	485	560	4.13
Spain	440	492	530	3.91
Total world	12,460	13,255	13,552	100

MSM: Million Square Metre

Morbi, a small industrial town near Rajkot, is the second largest tiles manufacturing cluster in the world, accounting for ~90% of the total production of ceramic tile products in India.

The market share of ceramic products in India is shown below:

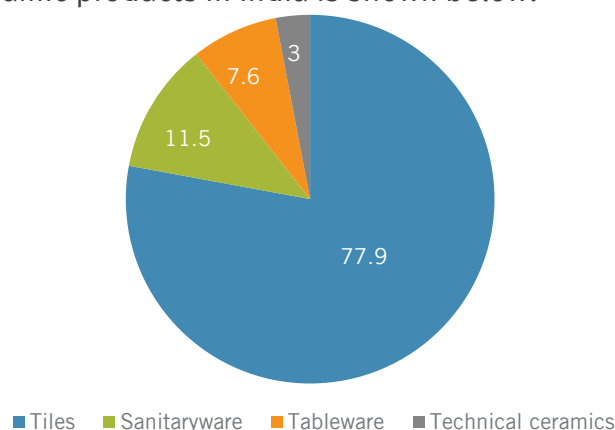

Figure 1: Ceramic Product Market Share (2017)

¹ Ceramic world review



The SME ceramic industry has developed in clusters in Morbi, Thangadh and Ahmedabad in Gujarat and in Khurja in Uttar Pradesh. Morbi cluster produces mostly tiles and sanitaryware products; Thangadh cluster produces sanitaryware; Khurja cluster produces crockery and electrical insulators; Naroda in Ahmedabad produces crockery items and Himmatnagar in Ahmedabad produces mostly tiles and crockery items. The table below lists the clusters, no. of ceramic units in each cluster and their major products.

Table 3: Cluster Level Details

Location	Products	No. of units (approx.)
Morbi	Ceramic tiles (major product), Sanitaryware, technical & industrial ceramics	700
Thangadh	Sanitaryware (major product), Refractories	160
Himatnagar	Wall & floor tiles	21
Naroda	Crockery	23
Khurja	Crockery, electrical insulators	220

Morbi, a small industrial town near Rajkot, is the second largest tiles manufacturing cluster in the world and accounts for ~90% of India's total ceramic tiles production. The main product segments are the Wall Tile, Floor Tile, Vitrified Tile and Industrial Tile segments. The market shares⁴ (in value terms) are 20%, 23%, 50% and 7% respectively for Wall, Floor, Vitrified and Industrial Tiles.

Indian sanitary basic segment is dominated by unorganized players whereas standard, premium and luxury segments are dominated by organized players. Pottery ware signifying crockery and tableware category being largely unorganized.

Ceramics industry is a highly energy-intensive industry. After raw materials, electricity and fuel cost is the second largest cost component in the total cost of production. The energy cost accounts for 25-30% of the total production cost. According to the estimates, 10-20% of energy saving is possible in the ceramic units by adoption of latest energy efficient technology, processes, best practices, etc.

⁴ Indian Council of Ceramic Tiles and Sanitaryware (ICCTAS) report



1.2. Ceramic Sector Growth Prospects

The key driver for the ceramic products in India is the boom in housing sector coupled with government policies fueling strong growth in the housing sector. Government focus on infrastructure development is expected to result in driving demand for Indian ceramics, sanitary ware and bathroom fittings industry. Indian government spending on construction and real estate, including affordable housing is set to boost demand for ceramic products in the country. With many new projects lined up in the country, the construction sector is growing at an approximate rate of 7 to 8 per cent. The demand for industrial ceramic products such as ceramic tiles, sanitary wares and pipes required in construction applications too are expected to increase.

Indian ceramic industry is dominated by ceramic tiles industry, with market of 4.9 Billion EUR in 2017; overall ceramic industry expected to grow at 9% CAGR to become 7.5 Billion EUR by 2022⁵. Indian sanitary ware market is estimated to be 560 million EUR in 2017; basic segment is dominated by unorganized players whereas standard, premium and luxury segments are dominated by organized players.

Ceramic product manufacturers face challenges due to the rise in the cost of production, which in turn hampers the profit margin of the manufacturers. The increase in the price of raw materials such as zirconium and titanium and fuel such as compressed natural gas (CNG) which constitutes 30% of the input cost for manufacturing ceramic tiles, increases the total cost of production.

The growth in tile industry was mainly driven by the transformation of ceramic tiles from being typically hygiene products into adornment and aesthetic solutions for every household. The potential is huge considering the per capita consumption of ceramic tiles in India. Currently it is at 0.50 square metre per person⁶ in comparison with over 2 square metres per person for like countries like China, Brazil and Malaysia.

⁵ *Status Quo and Outlook 2022: Indian Ceramics Industry, Market study by EAC International Consulting on behalf of Messe Muenchen India, March 2018*

⁶ *Indian Council of Ceramic Tiles and Sanitaryware (ICCTAS)*



1.3. Morbi Ceramic Cluster

Morbi is located in Rajkot district of Gujarat. It lies at a distance of 200 km from Ahmedabad and 65 km from Rajkot. The Morbi ceramic cluster houses more than 610⁷ units and has a cumulative industrial investment of over INR 8,000 crore. The industrial area produces Wall Tiles, Floor Tiles, Vitrified Tiles, Polished Glazed Vitrified Tiles, Twin Charged Tiles, Multi-colour Charged Tiles in various formats starting from 20 x 30 cm to 120 x 180 cm in a wide range of designs and colors. It also produces sanitary ware, industrial ceramics and technical ceramic products. It is the 2nd largest ceramic tiles producing cluster in the world and accounts for more than 90% of total ceramic production in India. The ceramic units in Morbi uses latest technologies and equipment imported from all over the world.

Unorganized tile manufacturers hold more than 50% of the tile manufacturing capacity and supplies significant quantity to organized players in India. Units in Morbi are exporting to countries like Middle East, Sri Lanka, Bangladesh, Africa, etc.

Clay, the most important material required for manufacturing ceramic tiles, is generally obtained from Rajasthan in India and other parts of Gujarat.

The various types of kilns operational in Morbi are generally tunnel kilns for sanitaryware and roller kilns for ceramic tiles. The roller kilns used for manufacturing tiles have computer-based firing control where the temperature profile is preset. On the other hand, the tunnel kilns have manual control.

The ceramic tile units in the Morbi cluster were earlier using either natural gas or gasification units (which burn coal to generate gas). With NGT's order in March 2019 to discontinue usage of all type of coal gasifiers considering its adverse impact on the environment, all the units have mandatorily switched to PNG for their fuel requirements. The ceramic tile units in the Morbi cluster now uses natural gas for roller kiln and coal for spray dryer. Other electrical energy consuming equipment in tiles manufacturing units are ball mills, spray dryer, press machine, pumps, compressors, etc.

There are four associations in Morbi providing various supports to the ceramic units for improving the product quality and energy efficiency – Vitrified Tiles Division, Wall Tiles Division, Floor Tiles Division and Sanitaryware Division.

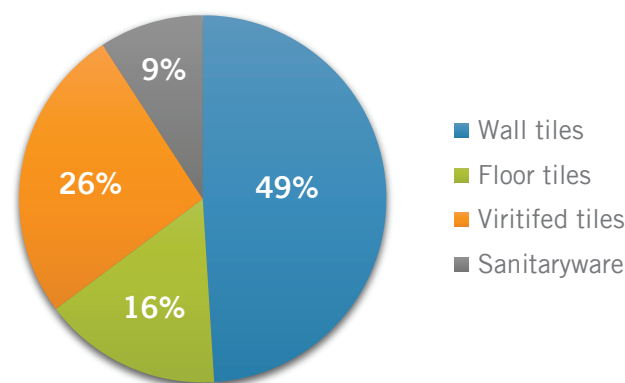
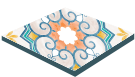
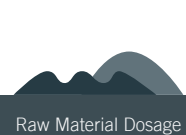

Figure 2: Ceramic units footprint in Morbi cluster

⁷ Source: Morbi Ceramic Association website



This Page Intentionally Left Blank





Manufacturing process and energy consumption



2. Manufacturing Process and Energy consumption

2.1. Ceramic Product Value Chain

The following figure indicates the value chain of ceramic manufacturing industry from raw materials to final products (end use).

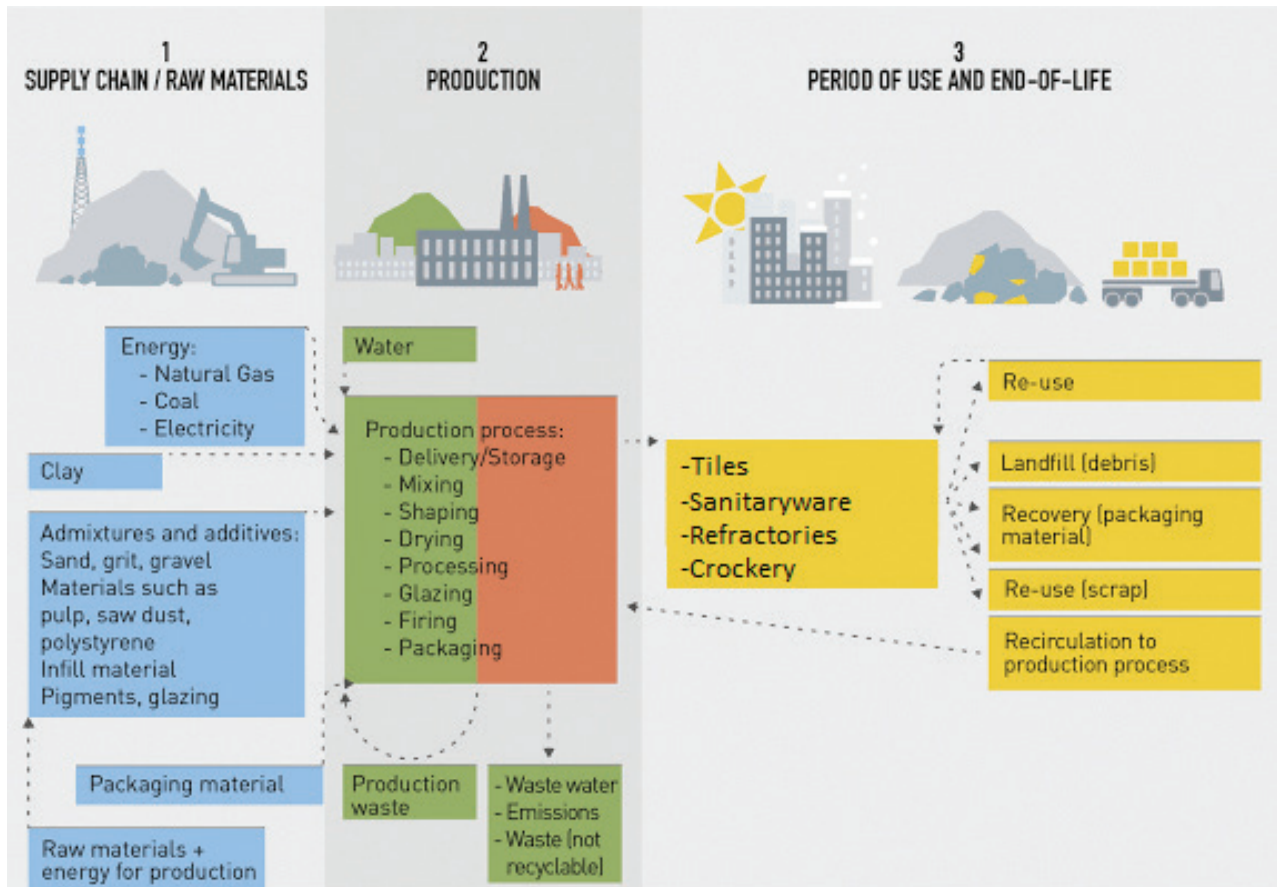

Figure 3: Ceramic product manufacturing process value chain

The major operations in ceramic manufacturing process is described below:

i) Raw Materials: This includes the raw materials and energy used for production.

a. Raw material for production:

Most of the units in Morbi cluster manufacture traditional clay based ceramic products.

- i. From the available local than clay in Thangadh, wankaner and nearby local areas.
- ii. Quartz, flint, feldspar, aluminium silicates, frits and glazes in Gujarat and in the neighbouring state of Rajasthan.

b. Energy for production: Ceramic manufacturing units uses both electrical energy and thermal energy for production. Electrical energy constitutes 15-20% of the overall consumption. Main areas of usage are kiln, ball mills, spray dryer fans, press machine, pump and compressor. The major amount of thermal energy is used as natural gas in kiln firing and drying. The solid fuels like Indonesian coal, lignite, charcoal and biomass, are used in spray dryer.



ii) Production Process:

Ceramic tile production process involves the blending, spray drying, pressing, drying, firing, quality inspection and dispatch, while sanitaryware production process involves the blending (ball mill & slurry handling), mould preparation, drying (cast house), glazing, firing, quality inspection and dispatch. Detailed process is explained in section 2.2.

iii) Final Products usage: The products are used in building, infrastructures, sanitation and other construction sectors.



2.2. Process Flow for Tile and Sanitaryware Manufacturing

Morbi ceramic cluster produces tiles & sanitary ware. The main difference between the ceramic tile and sanitary production is the process of shaping products.

In ceramic tile manufacturing, the biscuits are made with hydraulic press machines whereas in sanitaryware units, manual moulding is done

Ceramic tile manufacturing process:

The various types of tiles manufactured mostly have a common process of production, which is shown below.



Figure 4: Ceramic Tile Manufacturing Process Flow

Raw material blending:

Ball mills or blungers are used for grinding. Raw materials such as china clay, bole clay, than clay, talc, potash, feldspar and quartz are mixed with water in proper proportion and grinded in a ball mill to form a homogenous mixture, i.e. slurry. Ball mills has pebbles and inner lining, depending on raw material quality and quantity, the blending time varies; hence ball mills are operated in batch process.

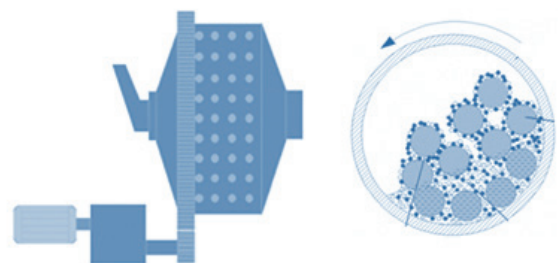

Figure 5: Raw Material Blending (Wet ball milling)





Figure 6: Slurry agitation and storage

Spray Drying: Spray Drying: Slurry transferred from storage tanks is sprayed into spray dryer through nozzles. Moisture, which is added in the grinding process in the ball mill is removed in spray dryers. Hot flue gases 550-600°C from heat source fired from lignite, Indonesian coal and bio mass absorbs the moisture from input slurry (35-40%) to output slurry with 5-7% moisture.

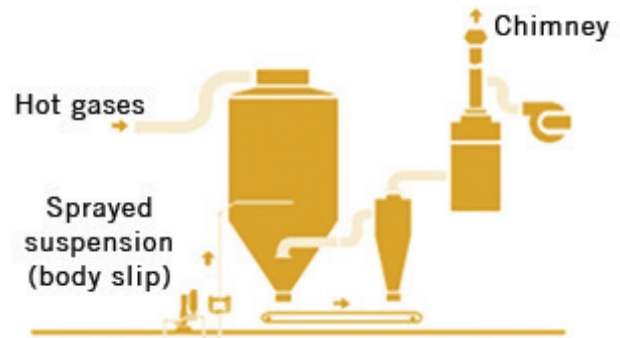

Figure 7: Spray Drying process



Figure 8: Pressing Machine

Drying: After press, biscuits containing about 5% to 6% moisture are sent to drier and dried to about 2% to 3% moisture level in case of vitrified tiles. In case of wall and floor tiles, biscuits are directly baked to a temperature of about 1,100 to 1,150°C and after glazing, they are baked again. In some ceramic units, hot air from kiln cooling zone exhaust is used in dryers, which saves energy consumption in driers.

Pressing Machine:

The product from the spray dryer is then sent to the hydraulic press where the required sizes of biscuit tiles are formed and sent to dryer through conveyer.



Figure 9: Tiles Drying

Glazing:

Glaze is separately prepared from glaze ball mill by grinding the following components: Silica, Alkalis, Lead, Boron, Zirconium, Iron, Chromium and Cobalt stored in storage tanks. The biscuits dried from the dryer enter glazing section where glazing is sprayed on the tiles. After glazing, tiles are sent for designing & firing.



Figure 10: Glazing

Kiln Firing:

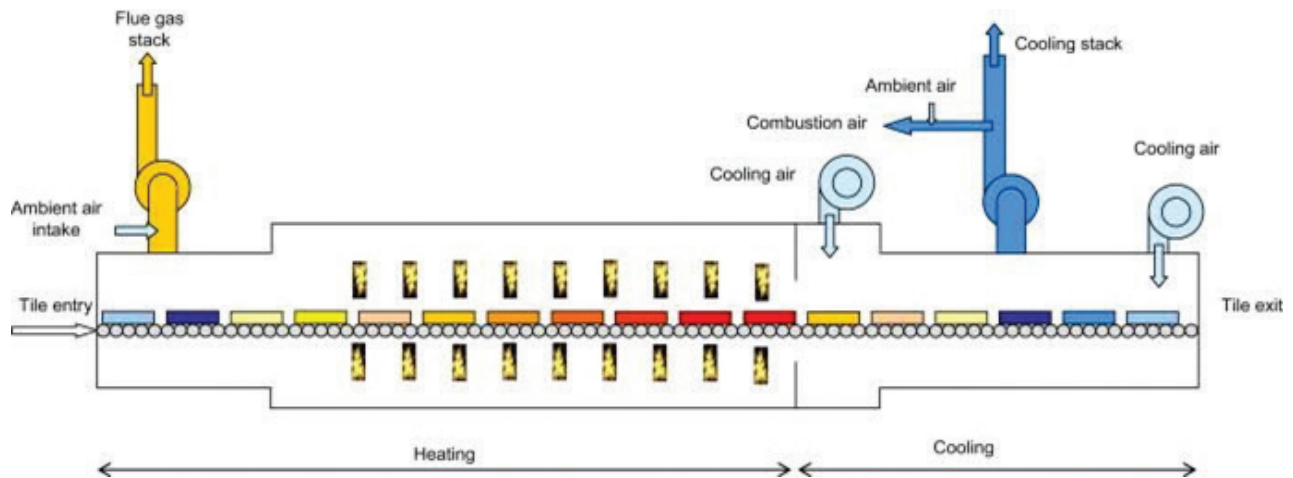

Figure 11: Roller Kiln firing

After glazing the biscuit tiles are sent to designing for printing the designs. After completion of designing the tiles are sent to roller kiln for firing. The fusion of material in ceramic tiles and glaze are transformed into glassy phase through vitrification in kiln firing zone at temperature $1,000^{\circ}\text{C}$ to $1,400^{\circ}\text{C}$. After the vitrification process the ceramic tiles to have high strength, resistance to heat and fire and chemical inertness.

The kiln firing is done in two stages

- 1) Preheating zone ($500 - 750^{\circ}\text{C}$)
- 2) Firing zone ($1,000 - 1,400^{\circ}\text{C}$).

After firing tile are cooled in two zones:

- 1) Rapid cooling zone ($600 - 900^{\circ}\text{C}$)
- 2) Cooling zone ($200 - 500^{\circ}\text{C}$)

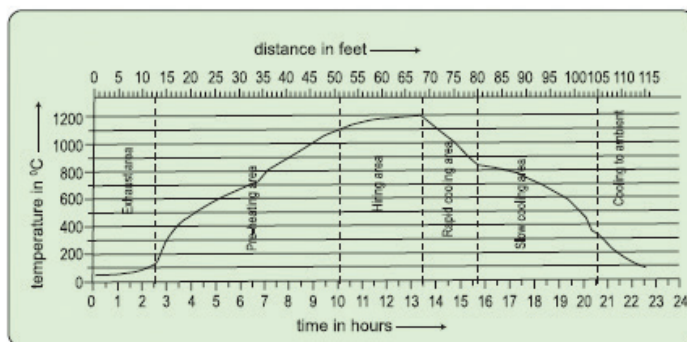

Figure 12: Firing Cycle

Ceramic sanitaryware manufacturing process:

The sanitaryware manufacturing process is described below in details:



Figure 13: Ceramic Sanitaryware Manufacturing Process Flow

Raw material blending

Ball mills or blungers are used for grinding. Raw materials such as china clay, bole clay, than clay, talc, potash, feldspar and quartz are mixed with water in proper proportion and grinded in a ball mill to form a homogenous mixture, i.e., slurry. Ball mills have pebbles and inner lining; depending on raw material quality and quantity the blending time varies, hence, ball mills are operated in batch process.

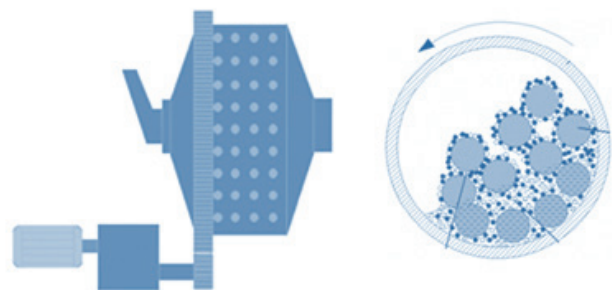

Figure 14: Raw Material Blending (Wet ball milling)



Figure 15: Slip agitation and storage

Slurry Agitation and transfer system:

After completion of wet grinding in ball mills, the slurry is stored in the underground tanks fitted with agitator motor in each tank, for continuous mixing to maintain uniformity and avoid settling of solid particle. Slurry is then pumped to mould through a slurry transfer pump.

Mould Preparation:

In this section the moulds are prepared as per the requirement of shape and size casting. The case mould is made in the moulding section by mixing of water with Plaster of Paris in a proper proportion. Once the mould is prepared, it is dried to remove the excess water from the mould. This stage is crucial to increase the life of the mould.



Figure 16: Mould Preparation



Figure 17: Cast House

Casting:

Sanitaryware has different types of casting like normal bench casting, beam casting, low-pressure casting and high-pressure. The slip is poured into the mould and allowed to form the casting layer on the mould. A drain hole is provided for draining excess slip and cast ware is allowed to dry. Casting is removed from the mould. In this stage, the ware known as greenware. This greenware is allowed to dry in atmospheric temperature for 5-7 days in natural drying using the ceiling fans.

Glazing:

Glaze is separately prepared from Glaze ball mill by grinding the following components: Silica, alkalis, lead boron, Zirconium, Iron, Chromium and Cobalt and stored in storage tanks. The sanitaryware dried from the casting section enters glazing section; around 1 mm thickness glaze is sprayed on the ware. After glazing, sprayed ware is loaded in kiln car for firing.



Figure 18: Glazing

Kiln Firing:

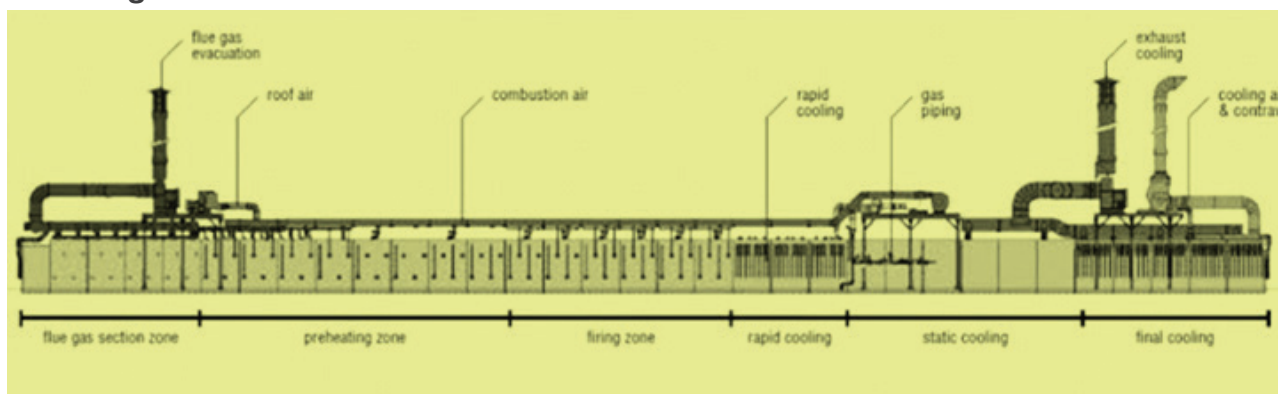

Figure 19: Tunnel Kiln firing

After glazing, dust and other impurities are removed from the ware by blowing air, then the kiln car with wares is sent to tunnel kiln for firing. In preheating zone, mechanically and

chemically combined water has been removed from the ware. At firing zone, at $1,250^{\circ}\text{C}$, all the raw material are fused together and glaze is fused evenly. In the cooling zone, sudden cooling is done to create a glossy surface. After firing, the wares are sent to quality inspection.

The kiln firing is done in two stages:

- 1) Preheating zone ($500-750^{\circ}\text{C}$).
- 2) Firing zone ($1,100-1,250^{\circ}\text{C}$).

After firing, tiles are cooled in two zones:

- 1) Rapid cooling zone ($600-900^{\circ}\text{C}$).
- 2) Cooling zone ($200-500^{\circ}\text{C}$).

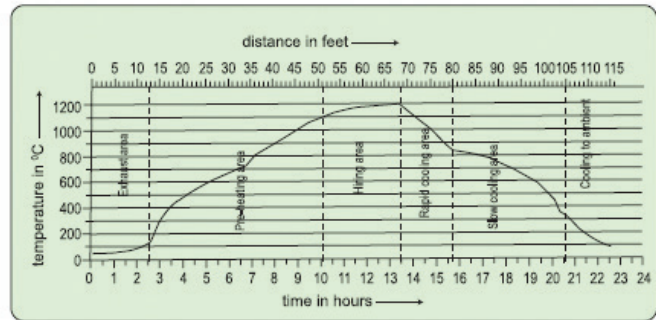

Figure 20: Firing Cycle

Quality Inspection:

In this stage of the process, all wares from the kiln are inspected and sorted according to the defects. If ware is defect-free, it will be sent to the packing section for packing.

Packing:

It is the final stage of the sanitaryware manufacturing/production process. All sanitaryware that pass quality standards are packed and dispatched to the warehouse.

2.3. Energy Consumption in Ceramic tiles & Sanitaryware Manufacturing Units

The ceramic tile & sanitaryware industry uses thermal energy for kiln firing, spray drying (tiles) and electricity for process and utilities. The cost of energy increasing continuously, which in turn increases the processing expenses and, therefore, the product cost. Energy costs typically constitute 30-40% of the overall manufacturing cost. The following tables provide an overview of major energy consuming areas within a tile & sanitaryware unit:

Table 4: Energy Consumption Overview for Ceramic Tile Unit

S No.	Equipment	Process Requirement	Primary Energy
1	Ball mill	Grinding	Electricity
2	Pumps	Slurry Transfer	Electricity
3	Spray dryer	For drying slurry	Coal
4	Compressed air, Blower and Utility	Process	Electricity
5	Ball mill and compressed air	Glaze preparation	Electricity
6	Roller kiln	Firing	NG
7	Vertical/Horizontal dryer	Drying	NG
8	Hydraulic Press Machine	Press shop	Electricity

Table 5: Energy Consumption Overview for Sanitaryware Unit

S No.	Equipment	Process Requirement	Primary Energy
1	Ball mill	Grinding	Electricity
2	Pumps	Slurry Transfer	Electricity
3	Ceiling fans and compressed air	Casting	Electricity
4	Ball mill and compressed air	Glaze preparation	Electricity
5	Tunnel kiln	Firing	NG

Energy consumption of tiles and sanitaryware unit depends on capacity of roller & tunnel kilns, spray dryer and the level of automation in kiln, spray dryer and ball mills. The industry uses energy in the form of fuel for kiln firing and electricity for process and utilities.

Energy costs typically constitute 30-40% of the overall production cost. The share of primary energy (thermal and electrical) in a typical manufacturing unit is primarily dominated by thermal energy.

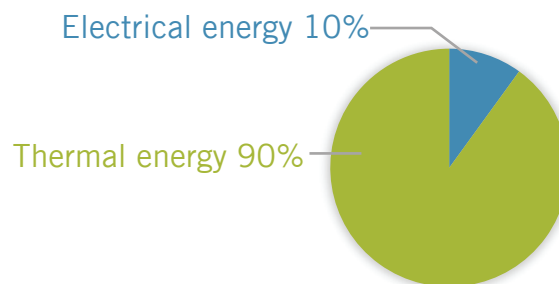

Figure 21: Energy Cost Breakup



Energy Balance in Ceramic Tile Unit

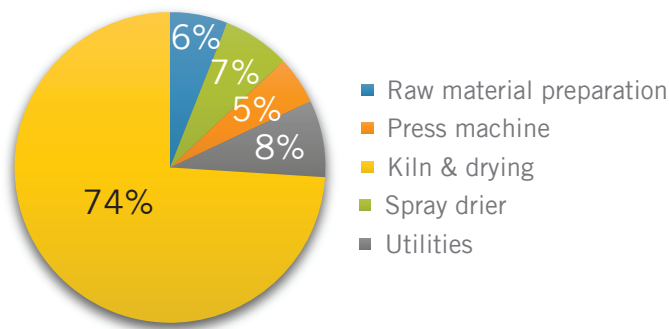

Figure 22: Energy Balance in Ceramic Tile Manufacturing Unit

In ceramic tile unit, the major energy consuming equipment includes roller kiln firing, vertical/horizontal dryer, spray dryer, press machine, ball mills, air compressors, lightings, pumps and motors. The figure above highlights the overall energy balance of a ceramic tile unit.

In sanitary ware unit, the major energy consuming equipment includes tunnel kiln firing, ball mills, air compressors, lightings, pumps, motor and ceiling fans. The figure below highlights the overall energy balance of a sanitaryware unit.

About 90% of the total energy is consumed in kiln firing and 10% is consumed in blending, which includes ball mills and slip agitation, while the remaining energy is consumed in other supporting activities such as slip transfer pumps, ceiling fans in cast house, utilities and packing.

Energy Balance in sanitaryware unit

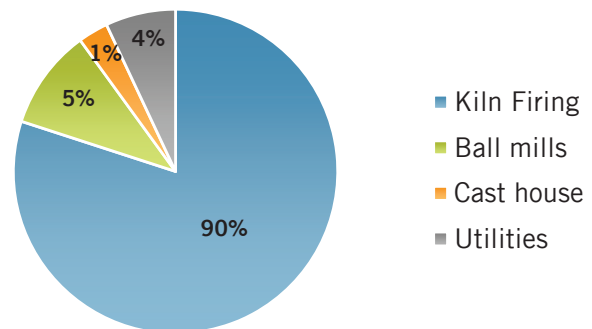

Figure 23: Energy Balance of a Sanitaryware Unit

Tiles & sanitaryware manufacturing units in Morbi have seen significant improvement in energy and productivity in the past few years due to increased levels of automation and technology development. This has helped in improving product quality and operating conditions while reducing product losses, maintenance time, manpower requirement and energy consumption. Innovations like optimization of ball mill operation using PLC and VFD, VFD on spray dryer fan, etc., have helped immensely. The ceramic units have also implemented VFD in screw compressor, installed energy efficient compressors and LED lighting, all of which has led to a conservation of energy as well as improvement in operating conditions.



2.4. Technology Status in Morbi Ceramic Cluster

Most of the units in Morbi have expanded over time with upgradation of equipment and technologies, expansion and automation & process control. Many of the units have also adopted latest technologies in kiln firing and other important areas.

Following is the technology status for the units in Morbi Ceramic sector:

Table 6: Technology Status – Morbi Ceramic Cluster

Sr. No	Area	Current Status
1	Energy Sources	<p>Thermal energy accounts for 80 to 90% of total energy use in ceramic units</p> <p>Electrical Energy – The units procure electricity from distribution companies in Gujarat (depending on region) and pay in the range of INR 6-8/kWh.</p> <p>Thermal energy is mostly met through natural gas. In Gujarat, the natural gas is available through City/Industrial Gas Distribution Network. In ceramic tile manufacturing units natural gas is used in kiln firing and dryers and coal is fired in spray dryer whereas in sanitaryware manufacturing units natural gas is used for tunnel kiln firing.</p>
2	Kiln Firing	<p>The ceramic tile manufacturing units in Morbi uses the roller kiln for continuous firing at 1,250°C.</p> <p>The sanitaryware manufacturing units in Morbi use continuous firing techniques in tunnel kiln at 1,250°C.</p> <p>Many of the units have upgraded kiln and have incorporated various energy conservation measures such as excess air control, automation, low thermal mass kiln cars (in tunnel kiln), etc.</p> <p>However, not all the units use Waste Heat Recovery and energy efficient burners and it presents a good opportunity for upgradation from conventional burners.</p>
3	Blending	<p>Units use ball mills to blend the raw material and prepare slurry. Many units have installed VFD on ball mills and some units have changed inner lining and grinding balls with alumina.</p> <p>However, not many units have implemented blunger technology in place of ball mills and there is a lot of potential for energy saving through blunger technology implementation.</p>
4	Slurry Transfer system	<p>The slurry is transferred from slurry collection tank to casting house using the electro mechanical driven pump. At present, units are using local slurry pumps, leaving a potential for implementation of energy efficient slurry pumps.</p>
5	Spray dryer (tile unit)	<p>The slurry transfer from tank to spray dryer through hydraulic pump and hot gases fired from the coal fired heat source at 650°C used to remove moisture from slurry and make it fine powder. The ceramic powder is then shaped in fine biscuit using hydraulic press machine in press shop</p>
6	Cast house (Sanitaryware)	<p>In sanitaryware units, castings that are made from mould are dried under natural air through ceiling fans. At present, most of the units have implemented the energy efficient BLDC fans and achieved a good amount of energy savings.</p>



Sr. No	Area	Current Status
7	Others	The other equipment and technologies to support process are pumping, electrical distribution, compressed air systems and others.
7a	Pumps	The pumps are installed for water and slurry transfer. The efficiency of the pumps needs to be evaluated, as many pumps are old. There is a good scope for improvement by avoiding throttling (installation of VFD, trimming of impeller) or by installation of high efficiency pumps (more than 70% efficiency).
7b	Electrical Distribution	Most of the units have installed APFC for power factor improvement. However, there are certain opportunities which units can tap in electrical distribution, such as installation of energy efficient transformers, optimal loading of transformers, installation of energy efficient motors, installation of VFD, soft starters, auto star delta conversion, power quality, etc.
7c	Compressed Air	Compressed air in units is used for instrument air application, mould preparation (in sanitaryware units) and glazing. Few units are using screw compressor and have installed VFD to avoid unloading. However, ceramic units can still tap certain opportunities in compressed air distribution and utilization, such as aluminium piping for leakage reduction, trans vector nozzle in cleaning applications, etc.



2.5. Benchmarking

Benchmarking is done to evaluate facility or unit's performance, viz., financial, production, energy etc. Benchmarking of energy use provides the means to compare a unit with other units or national and international best practices. Energy benchmarking is an effective tool for improving energy efficiency of an industrial unit. Energy benchmarking helps the units to understand the extent of difference in performance as compare to the best performing units, as well as the root cause for the differences.

The product wise specific energy consumption (for sanitaryware and tile products) is shown in below table:

Table 7: Product wise specific energy consumption for units in Morbi cluster

	Thermal energy (NG)		Electrical energy		Overall energy consumption
	UOM	Range	UOM	Range	
Sanitaryware	SCM/tonne	81.48-110	kWh/tonne	57-128	3.10-4.37
Wall & floor tiles	SCM/m ²	1.28-1.8	kWh/m ²	1.51-1.92	0.051-0.071
Vitrified tiles	SCM/m ²	1.51-2.11	kWh/m ²	3.71-5.01	0.067-0.093

Below table provides information regarding energy consumption in ceramic manufacturing in India.

Table 8: Industry benchmark for Indian Ceramic Products

	UOM	Industry benchmark
Ceramic Tiles (Thermal)		
Spray Drying	kj/kg	980-2,200
Drying	kj/kg	250-750
Once fired roller kiln	kj/kg	1,900-4,800
Twice fired roller kiln	kj/kg	3,400-4,600
Ceramic Tiles (Electrical)		
Pressing	kWh/kg	50-150
Drying	kWh/kg	10-40
Firing	kWh/kg	20-150
Sanitary Product (Thermal)		
Conventional tunnel kiln	kj/kg	9,100-12,000
Modern tunnel kiln	kj/kg	4,200-6,500
Roller	kj/kg	3,500-5,000



	UOM	Industry benchmark
Modern Shuttle	kJ/kg	8,500-11,000

The specific energy consumption (SEC) – overall SEC and by energy source for sanitaryware and tile products are shown in below tables:

	Thermal energy (NG)			Electrical energy			Overall energy consumption range	Overall Average value
	GJ/tonne			kWh/tonne			GJ/tonne	GJ/tonne
Sanitaryware	Min	Max	Avg	Min	Max	Avg		
	4	7	6	142	272	190	4.4-8.2	6.3
Floor tiles	MJ/m ²			kWh/sq m			MJ/m ²	GJ/tonne
	Min	Max	Avg	Min	Max	Avg		
	77	177	127	3.12	3.32	3.22	89-188 (Avg 175)	7.3
Wall tiles (full process)	MJ/m ²			kWh/sq m			MJ/m ²	GJ/tonne
	Min	Max	Avg	Min	Max	Avg		
	102	274	178	1.4	2.9	2.0	128-285 (Avg 182)	32
Wall tiles (partial process)	MJ/m ²			kWh/sq m			MJ/m ²	GJ/tonne
	Min	Max	Avg	Min	Max	Avg		
	58	105	84	0.9	1.4	1.3	63-117 (Avg 77)	7.8
Vitrified tiles	MJ/m ²			kWh/sq m			MJ/m ²	GJ/tonne
	Min	Max	Avg	Min	Max	Avg		
	63	134	108	3	6	4	73-148 (Avg 127)	1,418

Table 9: Equipment wise specific energy consumption – Sanitaryware unit

Sanitaryware	NG	Electricity
	SCM/tonne	kWh/tonne
Kiln	100-156	12.4-45
Ball Mill		11-31
Agitator		4-15

Table 10: Equipment wise specific energy consumption – Floor tile unit

Floor tile	Coal	NG	Electricity
	Kg/tonne	SCM/tonne	kWh/tonne
Kiln	168-329	126	6.9-13.5
Hot Air Generator	91-125		6.2-12.1
Dryer	18	15-19	12.5-24.8



Floor tile	Coal	NG	Electricity
Ball Mill			10-13
Agitator			1.2-2.8
Spray Dryer			1.9-2.6
Press			10-69
Finishing			22.6-24.8

Table 11: Equipment wise specific energy consumption – Wall tile unit

Wall tile	Coal	NG	Electricity
	Kg/tonne	SCM/tonne	kWh/tonne
Kiln (Single)	117	43	5.6-6.3
Biscuit Kiln	109-119	34-55	2.95-15
Glaze Kiln	108	33-48	4-6
Hot Air Generator	111-260		1.75-8.5
Dryer		28.5	4.85
Ball Mill			2-15
Agitator			0.5-2
Spray Dryer			1.9-6.6
Press			6-34
Glaze Mill			3.5-4.6
Finishing			2.3-10

Table 12: Equipment wise specific energy consumption – Vitrified tile unit

Vitrified tile	Coal	NG	Electricity
	Kg/tonne	SCM/tonne	kWh/tonne
Kiln	134-234	55-58	10.5-43
Hot Air Generator		95-153	6-28
Dryer	5-115*	2-15*	2.5-10.4
Ball Mill			2.4-24
Agitator			6
Spray Dryer			1-4
Press			7-29
Glaze Mill			3-43
Finishing			13-187

*included supplementary firing





Energy Efficiency Opportunities



3. Energy Efficiency Opportunities

3.1. Energy Efficiency in Ceramic Tile and Sanitaryware Units

The ceramic tile and sanitaryware manufacturing operations are highly energy intensive. The kiln firing and raw material blending are important and energy consuming areas for any manufacturing unit and improving energy efficiency in these areas is critical.

Over the years, there has been significant technology improvement in process and utilities area and units have been able to improve the energy efficiency in their operations. However, various opportunities exist for units to improve their energy efficiency and to be competitive and have environment-friendly operations; energy efficiency is critical to achieve these goals.

The manufacturing units have been implementing various energy conservation measures across various production process. The energy efficiency at a unit can be viewed at two levels – equipment & component level and process level. The energy efficiency at equipment or component level can be achieved by adopting various new technologies, preventive maintenance, optimum utilization, or replacement of old equipment with new and energy efficiency equipment. In addition to improving energy efficiency at equipment or component level, the Morbi ceramic cluster has made significant improvements in process level efficiency through various energy conservation measures such as automation, process control & optimization, process integration or implementation of new and efficient process.

Often, energy efficiency measures when implemented at the unit operations, not only result in improvement in energy efficiency but also in productivity and quality improvement as well. To summarize, the energy efficiency strategy for can be focused at three levels:

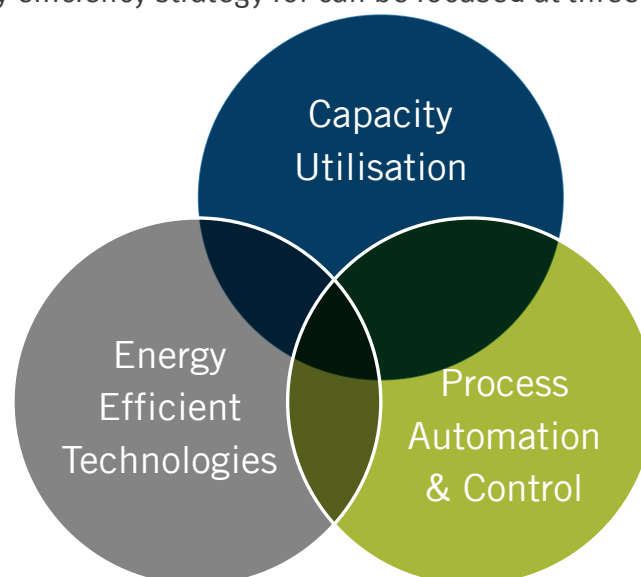

Figure 24: Energy Efficiency Approach – Morbi Ceramic unit



3.2. Energy Efficiency Measures

There are various energy consuming areas within a tile and sanitaryware manufacturing unit. Thermal energy is used for kiln firing and electrical energy for raw material blending in ball mill, utilities and other processes of the unit. Following figure provides an overview of energy usage in a ceramic tile and sanitaryware unit.

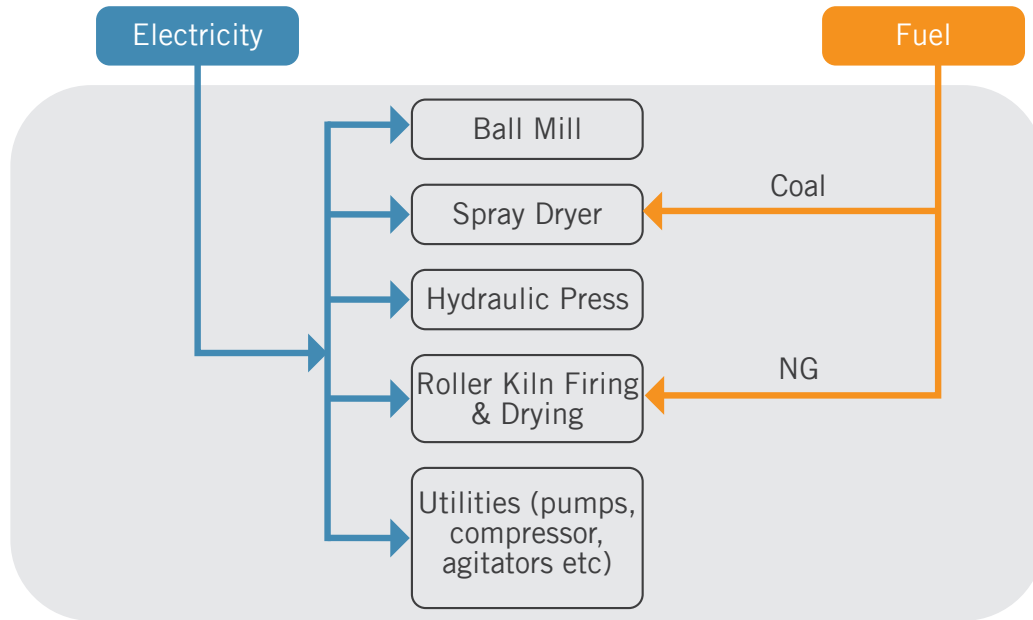

Figure 25: Ceramic tile manufacturing unit – Energy usage area

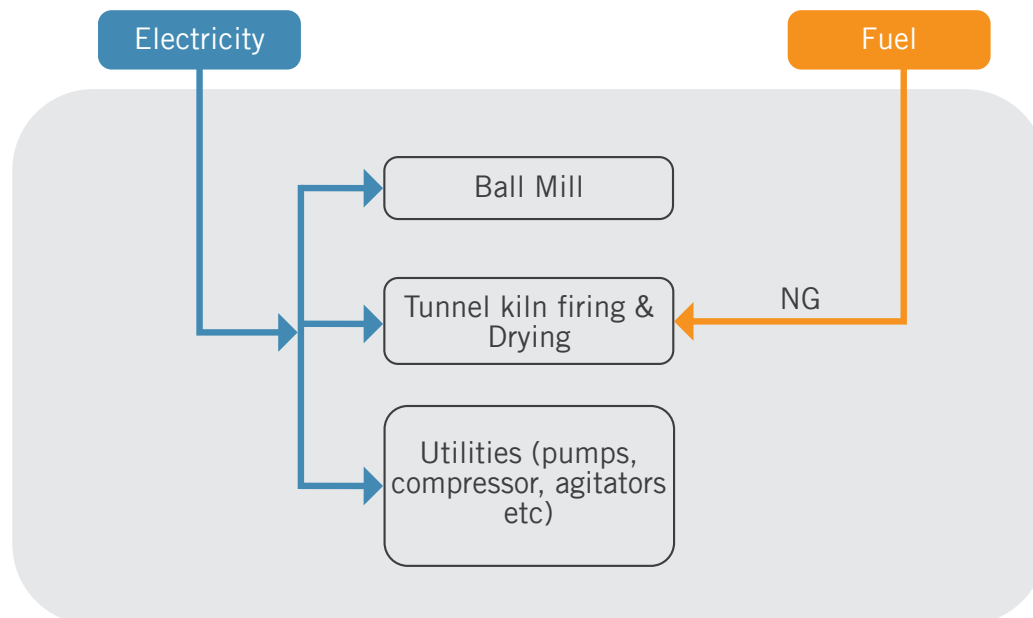

Figure 26: Sanitary ware manufacturing unit – Energy usage area

The following section provides an overview of some of the key energy efficiency measures in the major energy consuming areas in a ceramic unit and in further sections, some of the latest applicable technologies are covered.

3.2.1. Energy Efficiency in Roller & Tunnel Kiln Firing

Kiln firing is energy intensive and an important process as raw biscuit in ceramic tile and raw casting in sanitaryware are required to be fired at 1,250°C for fusion of raw materials. The energy efficiency in kiln is an important area as it accounts for approximately 30-40% of the energy cost. Following are some of the key energy conservation measures in kiln firing and insulation system:

Table 13: Energy efficiency measures in kiln

Energy Efficiency in Kiln	
Firing	
Use of energy efficient burner	Recuperation (Use of heat hot air from cooling zone as combustion air)
Excess air control system	Kiln automation & control
Maintaining adequate kiln temperature	Maintaining adequate kiln draft
Heat Losses reduction	
Improved insulation	Low thermal mass in kiln car
Proper kiln maintenance	Waste heat recovery from exhaust flue gas
Energy efficient coating for reduction of radiation loss from kiln	Energy efficient combustion and rapid cooling blowers
VFD on kiln combustion blowers	
Management Systems	
Effective monitoring of key parameters (fuel consumption, production, energy)	Root cause analysis



3.2.2. Energy Efficiency in Raw Material Preparation Process

Ceramic tile and sanitaryware manufacturing process involves blending of raw materials to form slurry, slurry storage and transfer system, coating house for shaping and glazing section. Some of the possible energy efficiency measures in process areas in sanitaryware units are highlighted in the table below.

Table 14: Energy efficiency in raw material preparation process

Energy Efficiency in Blending Systems (Ball mills)	
Blending (Ball mills)	
Maintaining the adequate media size and composition	Operating the ball mill at 65% - 75% of critical speed
Alumina lining inside the mill	High alumina grinding balls
Automation & control of ball mills through timer and PLC	Installation of VFD on ball mill motors
Energy efficient ball mill motor drive	V -belt to flat cogged belt
Slurry agitation and transfer system	
Use of energy efficient agitators	Energy efficient motors installation for agitation
Delta to star conversion of lightly loaded motors in agitators	Energy efficient slurry transfer pumps
Spray dryer (for tile manufacturing unit)	
Use of energy efficient fan	Energy efficient motors installation for spray dryer ID fan
Insulation to reduce radiation losses across spray dryer	Waste heat recovery from exhaust gas
Cast house (for Sanitaryware unit)	
Use of energy efficient BLDC ceiling fans for drying the raw ware	
Others	
Use of blunger technology in place of ball mill	Use of solar energy for pumping



3.2.3. Energy Efficiency in Utilities

The utilities such as compressed air, electrical distribution systems, lighting and other areas are also energy consuming sections in a ceramic manufacturing unit and here too, several energy efficiency improvement opportunities are available. Following table provides an overview of possible energy efficiency opportunities in utilities areas:

Table 15: Energy efficiency in utilities

Energy Efficiency in Utilities	
Compressed Air Systems	
Use of energy efficient screw compressors	Transvector nozzle for cleaning purpose
Optimum generation pressure	Use of VFD in compressor
Avoiding compressed air leakage	Energy efficient air dryers
Auto drain valves	Proper distribution systems
Pneumatic equipment to electric equipment	Appropriate ventilation in compressor room
Electrical Distribution Systems	
Automatic power factor controller	Harmonic filters
Energy efficient transformers	Optimum voltage and line balance
Optimum loading of transformers	Energy monitoring systems
Pumps	
Energy efficient pumps	Trimming of impellers
VFD for pumps	Pumping system layout
Motors	
Energy efficient motors	Star to delta conversion
Kvar compensators	Preventive maintenance
Optimum loading	Belt driven to direct coupled
Lighting & Fans	
Use of BLDC ceiling fans	Use of LED
Use of natural light (Light Pipe)	
Renewable Energy	
Solar PV Installation	Hybrid solar-wind system





Energy Efficient Technologies Case Studies



4. Energy Efficient Technologies – Case Studies

The following chapter focuses on some of the above-mentioned technologies which are promising and have been implemented in a few ceramic units and have great potential for implementation. Over the last few years, the units in Morbi ceramic cluster have implemented a lot of energy saving measures and these measures have been replicated in most of the other units within the cluster also. These technologies are described in more detail and wherever possible, a case reference from a unit that has implemented the technology has been included. In most of the examples, typical energy saving data, Greenhouse Gas (GHG) emission reduction, investments, payback period, etc., have been highlighted. As these case studies are included to provide confidence to ceramic tile and sanitaryware manufacturing unit to implement technologies, the applicability of these measures may vary from unit to unit and further technical and financial analysis would be required for individual units. Following case studies are mentioned in detail in the subsequent section:

Table 16: Case Studies for Morbi ceramic cluster

Sr. No.	Technologies
Kiln	
1	Waste heat recovery in roller kiln
2	Waste heat recovery in tunnel kiln
3	Energy efficient coating to reduce the radiation losses in kiln and reduce fuel consumption
4	Low thermal mass for reduction of kiln car losses in sanitaryware units
5	Improvement of kiln insulation in roller kiln to reduce radiation losses
6	Excess air control system to maintain optimum air-to- fuel ratio in kiln
Raw Material Blending	
7	Reduction in ball mill power by installation of VFD on ball mill drive
8	High speed blunger in place of ball mill
9	High alumina media in glaze ball mill in the place natural stone/pebbles
10	Replacement of inefficient centrifugal fans with energy efficient fans in spray dryer
Utilities	
11	Installation of VFD in screw compressor to avoid unloading
12	Installation screw compressor with VFD in place of inefficient reciprocating compressor
13	Energy conservation in compressor by modifying airline system
14	Installation of energy efficient ceiling fans in place of conventional fans
15	Installation of energy efficient pumps
16	Transvector nozzle in compressed air hose pipe for mould cleaning application



Sr. No.	Technologies
17	Installation of energy efficient motors in place of old rewinded motors in ball mill
18	Maximum demand controller for avoiding excess contract demand penalty
19	Power factor correction & harmonic mitigation at main LT incomer
20	Installation of VFD on agitator motor
21	Installation of on-off controller system in agitator motor
22	Installation of energy efficient motor in place of existing conventional motors in agitator system
Renewable Energy	
23	Solar rooftop system
New & Innovative technologies	
24	Solar-wind hybrid system
25	CFD application in spray dryer for improving heat transfer
26	Energy efficiency in ceramic kiln through utilization of HHO gas
27	Installation of energy efficient burners in place existing old conventional burner in kiln firing
28	Optimization of water consumption by installation of water softener unit
29	Installation of Energy Management System
30	Insulation improvement in Hot air generator for spray dryer
31	Excess air control system to maintain optimum air to fuel ratio in Hot air generator (HAG)



4.1. Case Studies in Kiln

4.1.1. Waste Heat Recovery in Roller kiln

Unit: Diliso Ceramics Jetpar Road, Morbi, Gujarat.

Base line details: The unit has installed a roller kiln for manufacturing tiles with different sizes as 12x18”, 12x24” and 12x36”. Kiln performance is directly related to the temperature maintained & thermal efficiency at various zones of kilns. There are three heating zones – preheating zone, firing zone & cooling zone. The tiles are heated to upto 1,200°C inside the firing zone and then rapidly cooled in the cooling zone by ambient air through cooling blowers. The cooling air gets heated to 250°C and exhausted. Use of this hot air directly for combustion of fuel (Natural Gas) can result in significant savings in fuel consumption in the Kiln.

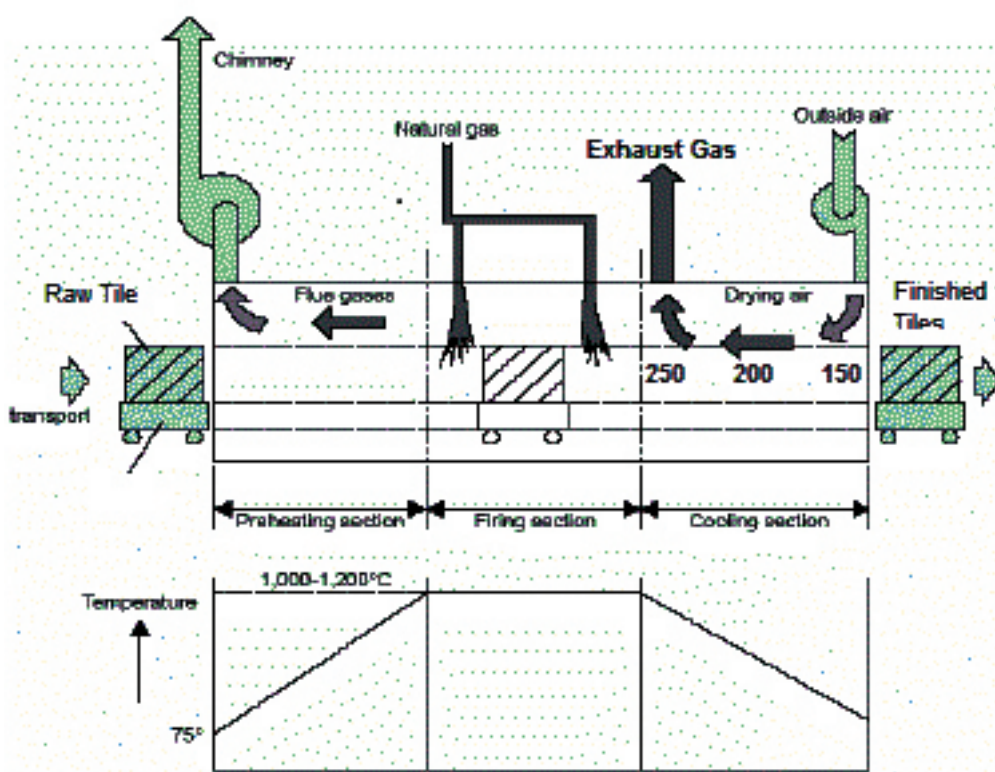

Figure 27: Before implementation – Exhaust chimney at 250°C

Implementation Details: The intervention involves shifting the exhaust vent from a temperature zone of 250°C to 200°C. The waste heat will be utilized inside the kiln & less combustion air at ambient temp will be sucked from the combustion blower. Consequently, higher temperature can be maintained in the kiln without any additional fuel.

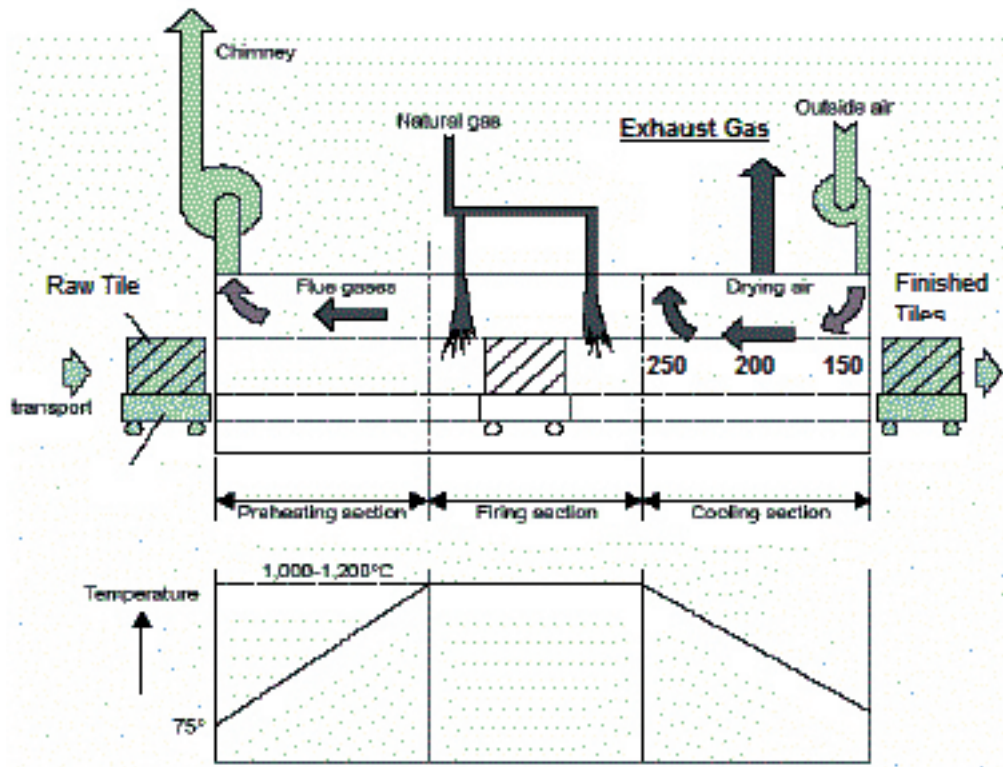

Figure 28: After Implementation – Exhaust shifted to 200°C temperature zone

Results:

- ❖ Reduced specific energy consumption in kiln
- ❖ Increased thermal efficiency
- ❖ Reduced fuel (natural gas) costs by 20%
- ❖ Increased production
- ❖ Increased insulation life by 50%

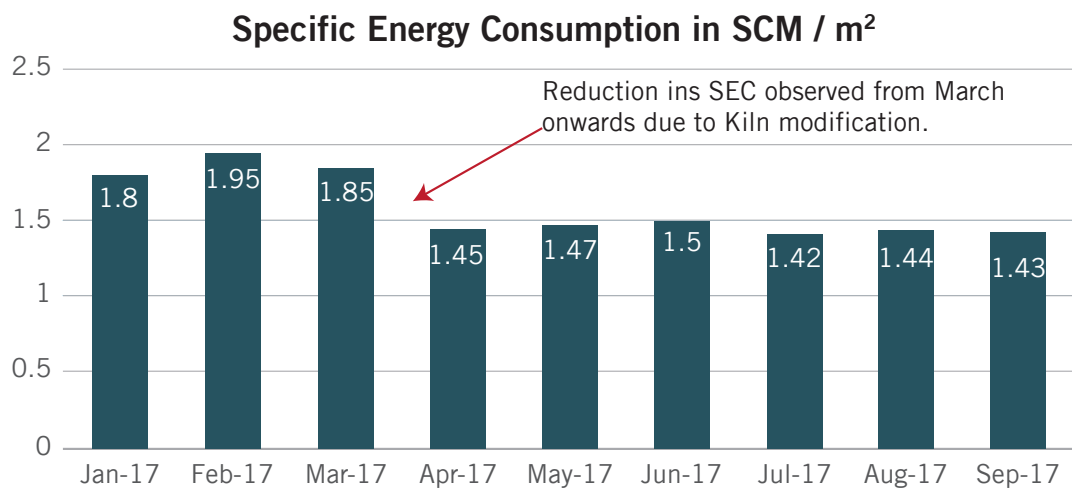

Figure 29: Reduction of SEC after Implementation

Cost Benefit Analysis:

The expected energy savings to be achieved by modification of new is 5,754 Lakh kCal annually. The annual monetary saving for this project is INR 19.26 Lakh, with an investment of INR 5.00 Lakh and a payback period of 3 months.

Table 17: Cost benefit analysis – WHR in kiln

Parameter	Value	UOM
Production	560	m ² /day
Natural gas consumption before intervention	1,050	SCM/Day
Operational hours	24	Hours /Day
Operational days	321	Days/annum
Natural gas consumption after implementation of WHR project	850	SCM/day
Annual gas consumption before intervention	3,37,050	SCM/annum
Annual gas consumption after intervention	2,72,850	SCM/annum
Annual gas savings due to implementation of measures	64,200	SCM/annum
Cost of natural gas	30	INR/SCM
Total thermal energy cost savings per annum	19.26	INR Lakh/annum
Total investment required to implement this measure	5.00	INR Lakh
Simple payback period	3	Months

Energy & GHG Savings



Replication Potential:

Implementation can be done in all other units where a similar kiln is used for production. However, periodic monitoring and measurement of the kiln's outside body temperature & exhaust air quality is essential. It is also suggested to check the insulation of piping on a daily basis.



Technology Supplier Detail for Waste heat Recovery

Table 18: Technology supplier for Waste Heat Recovery

Description	Details
Name of Company	Neptune Industries Limited
Contact Person	Mr Chandresh
Designation	General Manager
Contact	Mobile:+919879206992
Address	VT Industrial Park, Ahmedabad Mehsana High way, Jagudan, Mehsana 382710 (Gujarat) INDIA.



4.1.2. Waste Heat Recovery in Tunnel Kiln

Baseline details

The unit has installed a tunnel kiln of 15 TPD capacity for firing sanitaryware moulds. The open flame tunnel kiln is a continuous type kiln, wherein the raw product is fed at one side and on the other side the finished product is taken out. The raw product undergoes firing and cooling cycles as it moves from the front end to the back end of the kiln. Kiln performance is directly related to the temperature maintained & thermal efficiency at various zones of the kilns. There are three zones in tunnel kiln – preheating zone, firing zone & cooling zone. The temperature of the combustion air plays an important role in increasing the thermal efficiency of kiln. Exhaust heat is released from tunnel kiln by two ways: the first is flue gas released at a temperature of around 200-220°C and the second is hot air from final cooling zone at a temperature of around 120°C. At present, exhaust gas from tunnel kiln is released to atmosphere and combustion air is used at an ambient temperature.

There is a potential to reduce the fuel consumption in tunnel kiln by preheating the combustion air. Using the hot air from final cooling zone as a combustion air in tunnel kiln will lead to a decrease in fuel consumption.

Implementation Details

Hot air which is exhausted from the final cooling zone of tunnel kiln at a temperature of around 120°C, can be used directly as a combustion air in tunnel kiln. This will increase the thermal efficiency of firing and lead to savings of about 2 to 3% on total natural gas consumption in tunnel kiln.

Results:

- ❖ Reduced specific energy consumption
- ❖ Increased thermal efficiency
- ❖ Reduced fuel (natural gas) costs by 2-5%

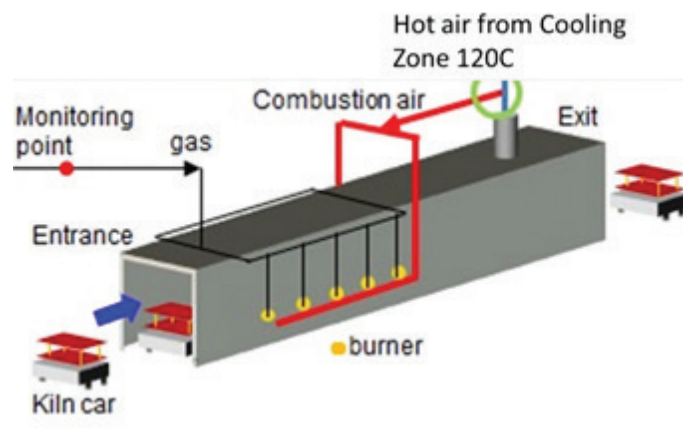

Figure 30: Use of hot air as combustion air

Cost Benefit Analysis

The expected energy savings to be achieved by using hot air as combustion air in tunnel kiln is 1,100 Lakh kCal annually. The annual monetary saving for this project is INR 3.66 Lakh, with an investment of INR 4 Lakh and a payback period of 13 months.

Table 19: Cost Benefit Analysis – Waste Heat Recovery

Parameter	Value	UOM
Production	15.00	Tonne/day
Natural gas consumption before installation of WHR system	1,650	SCM/day
Inlet combustion air temperature (before)	40	°C
Inlet combustion air temperature (after installation of WHR system)	120	°C
Natural gas consumption after installation of WHR system	1,613	SCM/day
Operational hours	24	Hours/day
Operational days	330	Days/annum
Saving in natural gas consumption	12,210	SCM/ annum
Cost of natural gas	30	INR/SCM
Annual monetary saving	3.66	INR Lakh/annum
Investment	4.00	INR Lakh
Simple payback period	13	Months

Energy & GHG Savings



Replication Potential

Implementation can be done in all other units where similar kilns are used for production. However, periodic monitoring and measurement of kiln excess air level in flue gas is essential.

Technology Supplier Detail:

Table 20: Technology Supplier Details – Waste Heat Recovery

Description	Details
Name of Company	Neptune Industries Pvt Ltd
Contact Person	Mr Chandresh
Designation	General Manager
Contact	Mobile:+919879206992
Address	VT Industrial Park, Ahmedabad Mehsana High way, Jagudan,Mehsana 382710 (Gujarat) INDIA.



4.1.3. Energy Efficient Coating Inside Kiln to Reduce the Radiation Losses in Kiln and Reduce Fuel Consumption

Baseline details

Maximum efficiency of the kiln is in the range of 30% to 40% and remaining 60% to 70% are losses from the kiln. Radiation losses accounts for 15% to 20% of total energy loss. In a roller kiln, the kiln surface temperature at firing zone is in the range of 80 to 100°C. Minimizing the radiation loss from the kiln surface will result in reducing the fuel consumption.

The unit has installed a roller kiln of production capacity 10,000 m²/day with a total length of 120 metres. The figure shows the various zones in kiln.

The surface temperature recorded at various zone is indicated in below table.

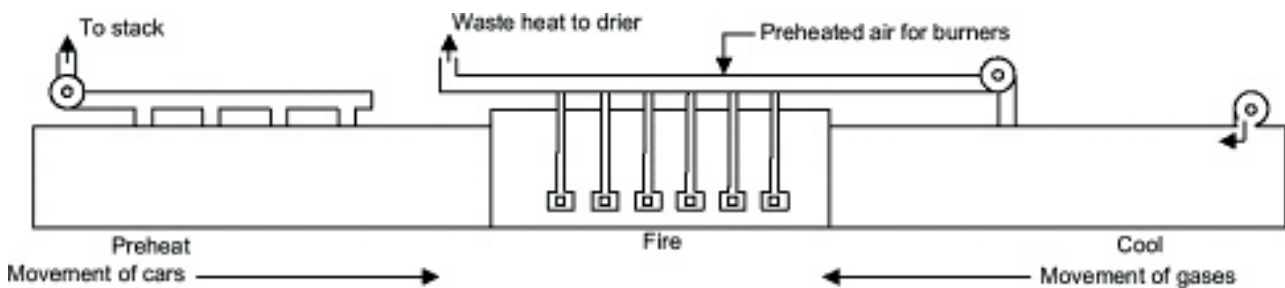

Figure 31: Various zones in Kiln

Table 21: Zone wise average surface temperature in Kiln

Zone	Left wall Avg temp (°C)	Right wall Avg temp (°C)
Pre-heating	57	58
Firing	83	94
Cooling Zone	72	62



Figure 32: Surface temperature at firing zone in a kiln

Implementation Details

The energy efficient coating is most suitable for ceramic kiln. It is applied in the kiln on bricks as well as on the exterior of the kiln. The coating is applied in multiple layers and allowed to dry. The coating can withstand temperature up to 1,500°C. This will reduce the surface temperature by 10 to 15°C.

Table 22: After Implementation Zone wise temperature

S.no	Before	After (Expected)
1	Preheating: 58°C	Preheating: 45-50°C
2	Firing Zone: 90°C.	Firing zone: 75-82°C

Results:

- ❖ Savings of up to 2 to 5% in fuel consumption.
- ❖ Life of coating would be 4-5 years.
- ❖ Life of ceramic fibre and refractory bricks will increase resulting increased results into indirect savings.

Cost Benefit Analysis

The expected energy savings to be achieved by use of energy efficient coating is 5,040 Lakh kCal annually. The annual monetary saving for this project is INR 17.00 Lakh, with an investment of INR 8.00 Lakh and a payback period of 6 months.

Table 23: Cost benefit analysis – Energy efficient coating

Sr. No.	Particular	Existing Situation	UOM
1	Production	6,510	m ² /day
2	Natural Gas Consumption (before)	8,500	SCM/day
3	Natural Gas Consumption (after)	8,330	SCM/day
4	Working days in annum	330	Days
5	Savings in Natural Gas Consumption	56,100	SCM/annum
6	Cost of Natural Gas	30	INR/SCM
7	Savings	17.0	Lakh INR/annum
8	Investment (for firing & preheating zone coating area of 2,500 sq ft)	8.0	Lakh INR
9	Simple payback period	6	Month



Energy & GHG Savings



Technology Supplier Details

Table 24: Technology Supplier Details – Energy efficient coating

Description	Details
	Supplier-1
Name of Company	Innovative Surface Coating Technology, Nagpur
Contact Person	Nikhilesh R
Designation	Co-Founder
Contact	Mobile: +91-8788384913
	Supplier 2
Name of Company	HIR Industries, Himatngar, Gujarat
Contact Person	David Patel
Designation	Director
Contact	Mobile: +91-9099021334



4.1.4. Low Thermal Mass for Reduction of Kiln Car Losses in Sanitaryware Units

Baseline details

The unit has installed a tunnel kiln of 15 TPD capacity for firing sanitaryware moulds. The open flame tunnel kiln is a continuous type kiln, wherein the raw product is fed at one side and on the other side the finished product is taken out. The raw product undergoes firing and cooling cycles, as it moves from the front end to the back end of the kiln. The material movement through the tunnel kiln is by kiln cars, run on rails. The kiln cars are like train bogies designed to hold the products. Natural gas is used as a fuel in tunnel kiln. The kiln cars are constructed with refractory and insulating bricks. Due to high thermal mass, kiln cars consume considerable amount of heat energy supplied to the kiln.



Figure 33: Existing high thermal mass refractory in kiln car

Implementation Details

The weight reduction of the kiln cars gives a significant amount of energy savings in tunnel kiln. Low thermal mass materials (LTM) are now being used for kiln car construction, which reduces the weight of the kiln car considerably. Weight of car furniture was reduced from 465 kg per car to 358 kg per car (23% weight reduction).



Figure 34: Low thermal mass in kiln car

Results:

- ❖ Reduced specific energy consumption in tunnel kiln.
- ❖ Increased thermal efficiency.
- ❖ Reduced fuel (natural gas) costs by 10-15%.

Cost Benefit Analysis

The expected energy savings to be achieved by use of low thermal mass in kiln car is 3,921 Lakh kCal annually. The annual monetary saving for this project is INR 13.10 Lakh, with an investment of INR 14.00 Lakh and a payback period of 13 months.

Table 25: Cost benefit analysis – Low thermal mass in kiln car

Description	Value	Units
Production	15	Tonne/day
No of kiln cars	40	Nos.
Present natural gas consumption for heating of car structure	680	SCM/day
Operational hours	24	Hours/day
Operational days	330	Days/annum
Natural gas consumption after implementation of LTM car	548	SCM/day
Saving in natural gas consumption	132	SCM/day
Saving in natural gas consumption	43,560	SCM/annum
Cost of natural gas	30	INR/SCM
Annual monetary saving	13.10	INR Lakh/annum
Investment	14.00	INR Lakh
Simple payback period	13	Months

Energy & GHG Savings

Replication Potential

Low thermal mass car technology can be replicated in all the ceramic units in the cluster. It is advised to take proper care regarding the strength of the kiln car during the redesigning. Implementation of the technology can be done in one kiln car and later replicated to the other kiln cars based on the results.

Technology Supplier Details

Table 26: Technology supplier details – Low thermal mass

Description	Details
Name of Company	Interkiln Advanced Technical LLP, Ahmedabad
Contact Person	Mr.Kushang Sanghavi
Designation	Managing Partner
Contact	Mobile:+91-9998980044
Email – ID	kushang@interkiln.co.uk
Address	Sanghavi Chamber, Near Navrangpura Police Station, Opp. Sweet Home Shop, Navrangpura, Ahmedabad – 3800009. Gujarat. INDIA..

Cluster Level Reference

1. Details of the project: Morbi

Table 27: Low thermal mass – Morbi cluster reference

Description	Details
Name of the company	Shree Neelkanth Sanitaryware
Person to be contacted	Mr Kantibhai Patel
Designation	Director
Contact number	+91-9925259179
Address for communication	N.H. -8, Opp. Dariyalal Resort, Morbi.



2. Details of the project: Thangadh

Table 28: Low thermal mass – Thangadh Cluster Reference

Description	Details
Name of the company	Anchor Sanitaryware
Person to be contacted	Mr Dushyant Sompura
Designation	Director
Contact number	+91-9825077447

3. Details of the project: Naroda

Table 29: Low thermal mass – Naroda Cluster Reference

Description	Details
Name of the company	Shiva Shakti Ceramics
Person to be contacted	Mr Dinesh Patel
Designation	Director
Contact number	+91-9879057081
Address for communication	Plot No.611,Ph-4,GIDC Naroda, Ahmedabad



4.1.5. Improvement of Kiln Insulation in Roller Kiln to Reduce Radiation Losses

Baseline details

The unit has installed a roller kiln of production capacity 5,032 m²/day for Vitrification process of wall tiles. Kiln performance is directly related to the temperature maintained & thermal efficiency at various zones of kilns. Kiln has three zones – preheating zone, firing zone & cooling zone. Firing cycle of the typical kiln is as follows.

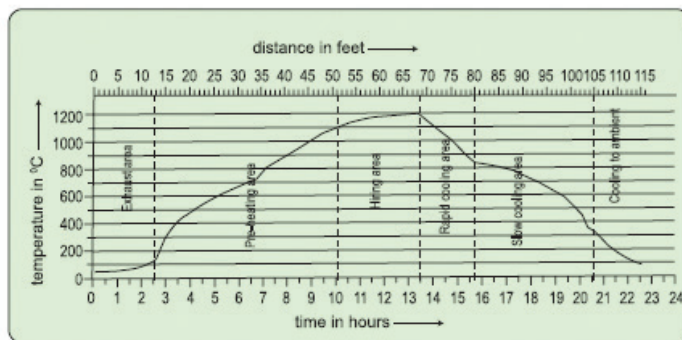

Figure 35: Firing Cycle

The kiln firing is done in two stages:

- 1) Preheating zone (500-750°C).
- 2) Firing zone (1,100-1,250°C).

After firing, tiles are cooled in two zones:

- 1) Rapid cooling zone (600-900°C).
- 2) Cooling zone (200-500°C).

Maximum efficiency of the Kiln is in the range of 30% to 40% and remaining 60% to 70% are losses from the kiln. Out of these losses percentage of radiation loss is coming out to be in the range of 15% to 20% of total energy supplied.

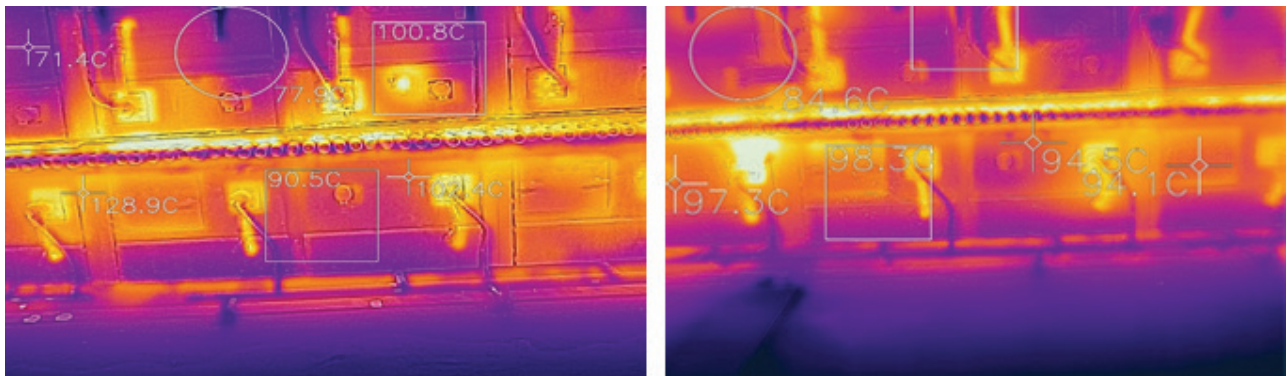

Figure 36: Thermal Image of Roller Kiln

Implementation Details

This radiation loss can be reduced by replacing the damaged insulation and improving the existing insulation of the kiln. Insulation improvement leads to saving in fuel consumption in kiln.

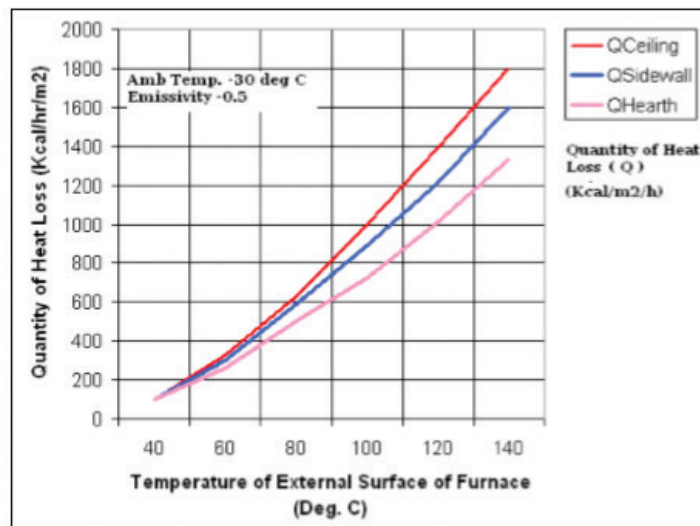

Figure 37: Quantity of Heat loss from Surface vs temperature

Results:

- ❖ Reduced specific energy consumption in kiln
- ❖ Increased thermal efficiency

Cost Benefit Analysis

The expected energy savings by replacing the damaged insulation with new is 5,206 Lakh kCal annually. The annual monetary saving for this project is INR 17.0 Lakh, with an investment of INR 20.00 Lakh and a payback period of 15 months.

Table 30: Cost benefit analysis for Kiln insulation Improvement

Parameter	Value	UOM
Production from kiln	2,200	m ² /day
Natural gas consumption before intervention	3,200	SCM/Day
Operational hours	24	Hours /Day
Operational days	350	Days/annum
Natural gas consumption after implementation of intervention	3,040	SCM/day
Annual gas consumption before intervention	11,20,000	SCM/annum
Annual gas consumption after intervention	10,64,000	SCM/annum
Annual gas savings due to implementation of measure	56,000	SCM/annum
Cost of natural gas	30	INR/SCM
Total thermal energy cost savings per annum	16.80	INR Lakh/annum
Total investment required to implement this measure	20.00	INR Lakh

Parameter	Value	UOM
Simple payback period	15	Months

Energy & GHG Savings



Replication Potential

Implementation can be done in all other units where a similar kiln is used for production. However, periodic monitoring and measurement of the kiln outside surface temperature is essential.

Technology Supplier

Table 31: Technology supplier – Kiln insulation

Description	Details
Name of Company	Cumi Morgan Advance Materials
Contact Person	Mr Alpesh Gupta
Designation	Director
Contact	Mobile: +91 9824013885

⁹ Detailed project report on kiln insulation improvement (Morbi ceramic cluster), Bureau of Energy Efficiency, 2010



4.1.6. Excess Air Control System to Maintain Optimum Air to Fuel Ratio in Kiln

Baseline details

Kiln performance is directly related to the temperature maintained at various zones & thermal efficiency of kiln. Excess air level in the combustion play a vital role in optimizing the fuel consumption and combustion efficiency of kiln firing. The excess air level is calculated based on the amount of oxygen in the exhaust flue gases.

$$\text{Excess air} = (O_2)/(21-O_2) \times 100\%$$

Where O_2 = % oxygen in flue gas

Excess air level in combustion air to be maintained at optimum level as too much of excess level results in excessive heat loss in exhaust flue gas and maintaining little excess air results in incomplete combustion and formation of carbon monoxide in flue gases. One of the causes of high excess air is improper or outdated control system in burner firing.

Table 32: Flue gas analysis & excess air in one of the kiln

Parameter	Value		UOM
	At kiln Exhaust	At Kiln Firing	
O ₂	17.3	8	%
CO	131	65	PPM
CO ₂	2.4	6.1	%
Excess air	467	61.54	%

Implementation Details

It is recommended to maintain %O₂ in flue gas in the range of 3-5%. For maintaining the optimum excess air level and air to fuel ratio, a PID based air and gas flow control system is to be installed in burner firing circuit.

In air flow control system, an O₂ sensor is to be installed in exhaust fuel gas and VFD on combustion air fan. The sensor senses the O₂ & provides the feedback/input to PID controller. The PID controller provide input to the combustion air fan VFD to control the speed and thereby control the volume of air to be required for complete combustion with optimum excess air.

¹⁰ Case Study – Cleaner Production in Ceramic Sector A strategy for Pollution Prevention prepared by Gujarat Cleaner Production Centre (Established by Industries & Mines Department, Government of Gujarat) March, 2016

¹¹ Case Study – Cleaner Production in Ceramic Sector A strategy for Pollution Prevention prepared by Gujarat Cleaner Production Centre



Results:

- ❖ Reduced specific energy consumption in kiln
- ❖ Increased thermal efficiency
- ❖ Reduced fuel (Natural Gas) costs by 10%.

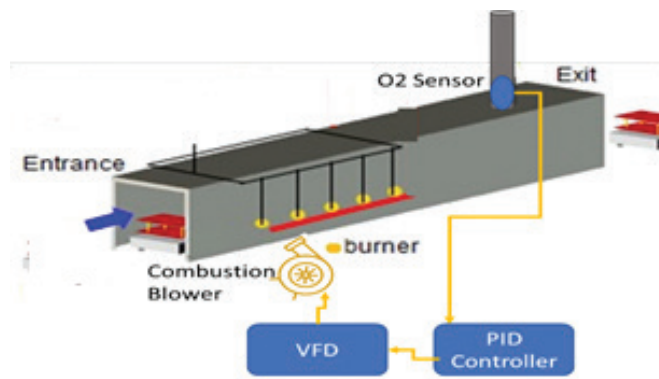

Figure 38: PID & VFD based Excess air control system

Cost Benefit Analysis

The expected energy savings to be achieved by optimizing the excess air is 1,960 Lakh kCal annually. The annual monetary saving for this project is INR 6.53 Lakh, with an investment of INR 14.00 Lakh and a payback period of 26 months.

Table 33: Cost benefit analysis for optimising excess air in the kiln

Parameter	Value	UOM
Production	15	Tonne/day
Natural gas consumption before intervention	1,650	SCM/day
Operational hours	24	Hours /day
Operational days	330	Days/annum
Natural gas consumption after implementation of intervention	1,584	SCM/day
Annual gas savings due to implementation of measure	21,780	SCM/annum
Cost of natural gas	30	INR/SCM
Annual monetary saving	6.53	INR Lakh/annum
Investment	14.00	INR Lakh
Simple payback period	24	Months
Simple payback period	18	Months

Energy & GHG Savings



Replication Potential

Implementation can be replicated in all the kilns.

Technology Supplier

Table 34: Technology Supplier Details – Air and Gas Flow Control System

Description	Details
Name of Company	Wesman Thermal Engineering
Contact Person	Mr Tushar Shah
Designation	General Manager
Contact	Mobile:+919879206992



4.2. Case Studies in Raw Material Blending

4.2.1. Reduction in Ball Mill Power by Installation of VFD on Ball Mill Drive

Unit: Uday Ceramic, Morbi

Baseline details

The unit has installed a ball mill with capacity 40 TPD and 250 hp drive for grinding of raw materials. Ball Mill is a batch type grinding process and used in all type of ceramic unit. As per the process requirement, motor should run at full speed during the start of batch and after a particular time period, it should rotate at lower speed. Existing unit has no control system installed and operates directly on starter.

Implementation Details

A VFD is a system for controlling the rotational speed of an alternating current (AC) electric motor by controlling the frequency of the electrical power supplied to the motor. A variable frequency drive is a specific type of adjustable-speed drive which controls the speed of motor according to the requirement. The speed of the motor can be reduced by installing variable frequency drive on Ball Mill/Blunger motor and operating speed can be programmed based on time. This will result in saving in power consumption to the extent of 15% in ball mills and blunger. This concept is applicable to glaze preparation ball mill in glaze section also. The project is successfully implemented in few ceramic units.

Results:

- ❖ Reduced specific energy consumption
- ❖ Reduction in electricity consumption in grinding process by 12%

Cost Benefit Analysis

The expected energy savings to be achieved by installing VFD in ball mill drive is 0.975 Lakh kWh annually. The annual monetary saving for this project is INR 6.82 Lakh, with an investment of INR 5.50 Lakh and a payback period of 10 months.

Table 35: Cost benefit analysis VFD in ball mill

Parameter	Values	UOM
Capacity of ball mill	40	MT/day
Ball mill motor capacity	250	hp



Parameter	Values	UOM
Operational hours	12	hrs/day
Operational days	330	Days/annum
Ball mill annual energy consumption (before)	6,50,226	kWh/annum
Ball mill annual energy consumption after installation of VFD and optimizing the speed (15% savings)	5,52,692	kWh/annum
Annual energy savings	97,534	kWh/annum
Annual monetary savings	6.82	INR Lakh/annum
Investment for VFD	5.50	INR Lakh
Simple Payback Period	10	Months

Energy & GHG Savings



Replication Potential

The project can be implemented in all other units where a similar kind of ball mill is used. Also, all new units & green field projects can implement this project.

Technology Supplier Details

Table 36: Technology supplier details for VFD

Description	Details
Name of Company	Danfoss Industries Pvt Ltd
Contact Person	Mr Hiran Thakkar
Designation	Manager
Contact	Mobile: 7940327341
Address	Ahmedabad



4.2.2. High Speed Blunger in Place of Ball Mill for Raw Material Grinding Process

Baseline details

In ceramic product manufacturing process, ceramic body preparation is one of the important processes. This process includes mixing of raw material with water to produce slurry. Most of the units in the cluster use ball mills for this operation ranging 2 MT to 20 MT capacity. Generally, ball mills will consume more time in loading and unloading as material is to be fed from small opening at the top. This in turn requires more manpower. It also requires grinding media for the operation, which will consume half of the space, so less productivity is achieved when compared to blunger technology.

The starting torque of ball mill motor is high due to uneven starting load, which consumes more power than the normal operation.



Figure 39: Conventional ball mill system

Implementation Details

Blungers are machines which can rapidly blunge raw material without changing non plastic raw material structure using stator rotor mechanism. The turbo blunger is a heavy-duty blunger used for rapid preparation of slip, achieving an 80% reduction in the blunging time compared to normal propeller-type dissolvers. It is operated by means of a special rotor fixed to the bottom of the tank, which propels the material against a ring of fixed paddles (1st phase). An auxiliary impeller, available on request, is fixed at a point halfway up in the tank for the blending of material in powder form (quartz, feldspar) with the slip (2nd phase). The average dissolving time for raw or already treated clay, including loading and unloading operations, is approx. 2 hours for a liquid with a specific weight of 1.4 kg/m³. The average duration of the 2nd phase is 1 hour for a liquid with a specific weight of 1.8 kg/m³. Due to less cycle time (2 to 2.5 hrs) as compare to ball mill and less weight, energy saving is achieved.



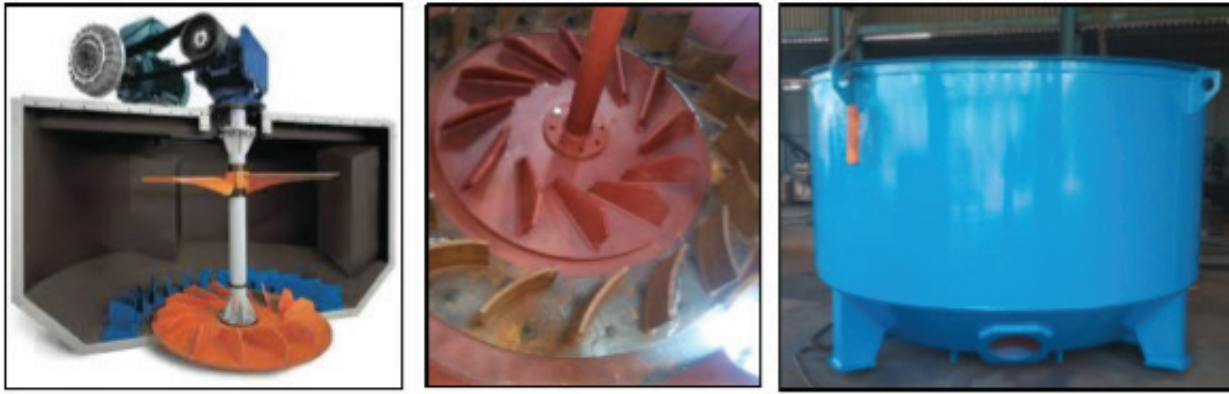

Figure 40: High Speed Turbo Blunger

Cost Benefit Analysis

The expected energy savings to be achieved by use of High Speed Blunger is 0.99 Lakh kWh annually. The annual monetary saving for this project is INR 6.45 Lakh, with an investment of INR 12.00 Lakh and a payback period of 23 months.

Table 37: Cost benefit analysis – High speed blunger

Parameter	A	B	UOM
	Ball mill	High speed blunger	
Charge Production	24	24	MT/day
Capacity	6	5	MT
No of ball mills/blunger	2	2	Nos
Motor capacity	40	20	hp
Power consumption	23.8	14	kW
Operational hours for one charging	5	3	hrs/batch
Power consumed in 720 MT charges per month	14,323	6,048	kWh/month
Total power consumption per annum	1,71,876	72,576	kWh/annum
Electricity cost per annum	11.17	4.71	INR Lakh
Annual monetary saving		6.45	INR Lakh/annum
Investment		12.00	INR Lakh
Simple payback period		23	Months

Energy & GHG Savings



Replication Potential

Learnings from successfully implementing high speed blunger technology in two ceramic units can be used very well to replicated in the other units in the cluster.

Technology Supplier Details

Table 38: Technology supplier details – High speed blunger

Description	Details
Name of Company	Dynovo Global Solutions Pvt Ltd, Mumbai
Contact Person	Mr. Jatan Shah
Designation	Managing Partner
Contact	Mobile: +91-9699817245
Address	203, Crystal Tower, 75 Gundavali Road No. 3, Off, Sir Mathuradas Vasanji Rd andheri East, Mumbai, Maharashtra 400069



4.2.3. High Alumina Media in Glaze Ball Mill in the Place Natural Stone/Pebble

Unit: Dynamic Ceramics, Navagam Road, Thangadh, Gujarat.

Baseline details

Ball mills are used for raw material and glaze grinding. The grinding of the material takes place due to the impact of the balls inside the ball mill. Most of the units in the cluster use natural stone as a media for grinding. Generally, these media are mined or naturally available stoned pebbles and are very irregular in shape and size. Such non-uniform grinding media take higher time for grinding and generate higher residue.



Figure 41: Mined Stone Pebble



Figure 42: High Alumina Ball

Implementation Details

As compared with natural pebbles grinding media, the alumina grinding balls have better performance in terms of wear resistance, uniform size, high density and high mechanical strength. The high density and ultra-hardness of the alumina grinding ball enable increased loading of ball mill. The alumina grinding ball is compact and uniform in shape, increasing the colliding probability and grinding efficient. The

alumina grinding ball can help in less contamination to the raw material and keep the chemical composition stabilized. Thus, the alumina grinding ball is a better option for glaze grinding that ensures quality of production. Other benefits of using alumina balls is wear & tear of balls which is about 0.2%, is very less as compared to natural stone/pebble, which is about 2.0%.

Cost Benefit Analysis

The expected energy savings to be achieved by use of high alumina balls in place of stone/pebble is 0.375 Lakh kWh annually. The annual monetary saving for this project is INR 2.52 Lakh, with an investment of INR 5.00 Lakh and a payback period of 23 months.



Table 39: Cost benefit analysis – High Alumina ball/Lining Grinding

Parameters	Natural Media	High Alumina	Units
Electrical motor capacity*	15	15	hp
Grinding hour for one charge	21	11	Hrs
Power consumed per one charge	234.4	122.7	kWh
Total Charge per month	28	28	
Total power consumption per month	6,562	3,437	kWh
Cost of power per unit	7	7	INR/kWh
Cost of power consumption per month	0.45	0.24	INR Lakh
Monetary savings annum	2.52		INR Lakh/annum
Investment	5.00		INR Lakh
Simple payback period	23		Months

* Considering ball mill size of 6 FT X6FT with material load of 2,000 kg grinding media balls

Energy & GHG Savings



Replication Potential

It can be replicated in all ball mills operating with natural stone/pebble as grinding media.



Technology Supplier Details

Table 40: Technology Supplier Details – High alumina grinding balls

Description	Details
Name of Company	Parishram Enterprise, Thangadh
Contact Person	Mr. Vinu Bhai
Designation	Managing Partner
Contact	Mobile: +91-98253 75834
Address	Thangadh



4.2.4. Replacement of Inefficient Centrifugal Fans with Energy Efficient Fans in Spray Dryer

Unit: Murugappa Morgan Thermal Ceramic Limited, Kalol

Baseline Scenario

In ceramic tile manufacturing process, centrifugal fans and blowers are installed in various areas like spray dryer fan, kiln combustion, kiln preheating, rapid cooling fan and cooling fan with connect load varying from (15-30 hp for kiln blowers and 100-150 hp for spray dryer fan).

In centrifugal fans, to achieve maximum operating efficiency the operating point should be very close to the design point. Any mismatch in terms of operating pressure or capacity with the design parameters, would result in lower operating efficiency and would result in higher power consumption. The reasons for lower operating efficiency could be over sizing of the fan, ageing and wearing of impeller.

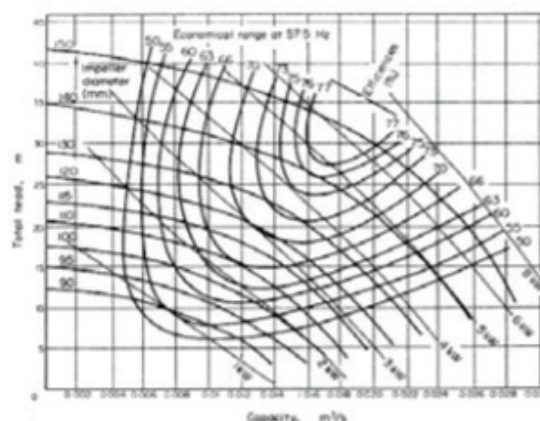

Figure 43: Typical characteristic curve of centrifugal fan

Implementation Details

The latest centrifugal fans are available with operating efficiency as high as 80%. Hence there is a good potential to save energy by replacing the existing fans with correct size high efficiency fans. During a study to measure the actual efficiencies of the fan the following parameters were measured.

- ❖ Actual Flow delivered by the fan in m^3/ sec
- ❖ Actual Head developed in mmWC
- ❖ Actual Power consumed in kW

Based on the actual measurements it was estimated that the operating efficiencies of fans are in the range of 45% & 47% respectively. The typical bench mark for efficiencies for these applications is 75%.

Table 41: Operating parameters of existing fans

Parameter	Unit DC Fan	PRYO Wool Bin fan	UOM
Fan flow	10,258	30,495	m ³ /hr
Head Developed	245	438	mmWc
Motor power drawn	22	200	kW
Fan operating efficiency	45.03	46.65	%

Cost Benefit Analysis

The expected savings by installation of energy efficient centrifugal fan for spray dryer and combustion blower is 1.598 Lakh kWh annually. The annual monetary saving for this project is INR 11.18 Lakh with an investment of INR 4.35 Lakh and payback for the project is 6 months.

Table 42: Cost Benefit Analysis - Energy efficient centrifugal fans

Parameter	Unit DC Fan	PRYO Wool Bin fan	UOM
Fan flow	10,258	30,495	m ³ /hr
Head developed	245	438	mmWc
Motor power drawn	22	200	kW
Efficiency	45.03	46.65	%
Energy efficient fan flow	10,500	31,000	m ³ /hr
Energy efficient fan head	260	450	mmWc
Energy efficient fan power drawn	11	75	kW
Energy savings	15,840	1,44,000	kWh/annum
Energy savings	1.10	10.08	INR Lakh /annum
Investment	0.55	3.80	INR Lakh /annum
Simple payback period	6	5	Months



Energy & GHG Savings



Replication Potential

Learning from successfully implementing energy efficient centrifugal fans can be applied in the areas of spray dryer and kiln combustion fans in entire ceramic tile manufacturing units.

Technology Supplier Details

Table 43: Technology supplier details – Energy efficient centrifugal fans

Description	Details
Supplier Name	Tech Flow Enterprise Pvt Ltd
Address	Rajkot
Contact Person	Mr. Bharat Davda
Phone No	+91-9978224704



4.3. Case Studies in Utilities

4.3.1. Installation of VFD in Screw Compressor to Avoid Unloading

Baseline Scenario

Compressed air in ceramic unit is used for instrument air application, mould preparation and glazing. The ceramic unit under consideration has installed a 30 kW screw compressor to cater to the requirements in the process & instrumentation section. The maximum working pressure of the compressed air in the system is in the range of 6-7 kg/cm². The operating characteristics of the compressor is as shown:

Table 44: Compressor loading pattern

Tag No	Load %	Unload %	Load power, kW	Unload power, kW
Air compressor	60.5	39.5	22 kW	7.6 kW

It can be seen that the loading of the compressor is only 60.5%. As the actual compressed air requirement for the process is lesser than the capacity of the compressor, compressor is operating in unloading condition for 39.5 % of the time resulting in waste of energy. During the unload condition, there is no useful work done by the compressor but the motor is in operating condition resulting in wastage of power. Avoiding or reducing the compressor unloading will result in power saving.

Concept of VFD

Any compressor is designed to go into load & unload conditions. The load & unload pressures for any compressed air system is set such that the average pressure delivered will be the required system pressure. The higher the pressure set point, more will be the power consumption of the compressor.

Also, in the present scenario, the installed compressor is of much higher capacity as compared to the system requirement, which is clear from the 39.5% unload that the compressor is operating with.

The compressor unloading can be avoided by installing variable frequency drive (VFD) in the compressor. The difference between the normal & VFD condition in a compressor is as shown below:



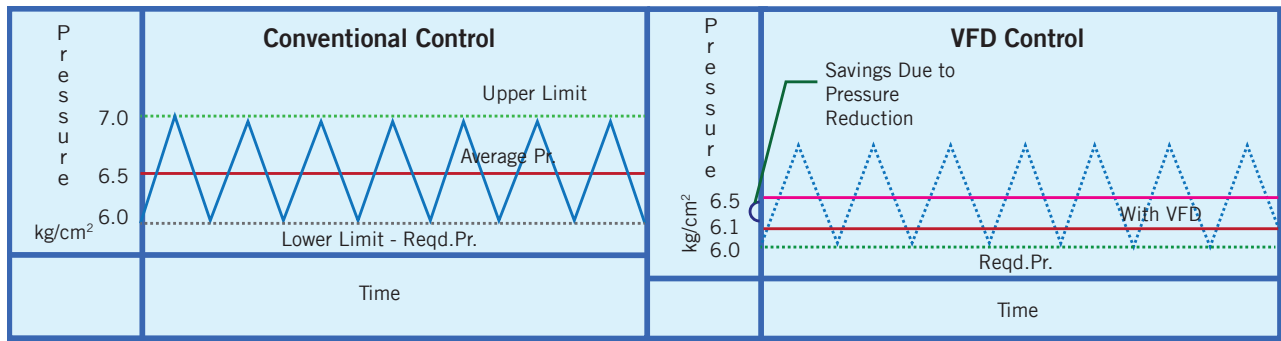

Figure 44: Capacity control of compressor

For example, for a compressor operating between load pressure of 6 kg/cm² & unload pressure of 7 kg/cm²; the average pressure is 6.5 kg/cm², (bandwidth 1 kg/cm²). The power consumption of the compressor operating constantly at 6 kg/cm² with VFD comes down by 5 to 6%. By installing a VFD, it is possible to maintain a bandwidth of 0.1 kg/cm². As can be seen from the figure, the VFD can be given a set point equal to that which is required in the system. The additional power that the compressor consumes over the required pressure will be the savings achieved.

Implementation details

It is recommended to install VFD and operate that with closed loop for all the above listed compressor to avoid the unloading of the compressor. The feedback for VFD can be given as required receiver pressure. By installing VFD, the compressor can be operated in a pressure bandwidth of ± 0.1 bar. Saving potential of 7.6 kW is possible by installation of VFD in the air compressor.

Cost Benefit Analysis

The expected savings by installation of VFD in the compressor is 18,249 units annually. The annual monetary saving for this project is INR 1.03 Lakh with an investment of INR 0.90 Lakh. Payback period for the project is 11 months.

Table 45: Cost Benefit Analysis

Parameters	Value	UOM
Unloading power of compressor	7.6	kW
Percentage unloading	30.5	%
Power savings	2.31	kW
Annual operating hours	7,900	hrs
Annual energy savings	18,249	kWh
Power cost	5.66	INR/kWh
Annual savings	1.03	INR Lakh/annum



Parameters	Value	UOM
Investment	0.99	INR Lakh
Simple payback period	11	Months

Energy & GHG Savings



Technology Supplier Details

Table 46: Technology Supplier Details – VFD for air compressor

Description	Details
Supplier Name	Tirupati Automation
Address	Shiv Plaza-2, Shop No-14 & 15, Matel Road, At- Dhuva, Ta. Wankaner, Dist. Morbi (Guj)
Contact Person	Bhavesh Vamja
Email Id	tirupatiautomation@gmail.com
Phone No	+91-9879411415 , +91-8000682152



4.3.2. Installation Screw Compressor with VFD in Place of Reciprocating Compressor

Baseline Scenario

Compressed air in ceramic units is used for instrument air, mould preparation and glazing process. Most of the units are using reciprocating type compressors without any automation; these compressors run on load/unload mode. The percentage of loading depends on the process requirement. Generally, compressor in ceramic units run on 60–70% in loaded condition remaining 30–40% in unload condition. During unload condition, the compressor does not deliver any air, but consumes unload power, which increases the specific power consumption.

On other hand, reciprocating compressor due to its design is prone to wear & tear and thus the compressor volumetric efficiency reduces over a period of time.



Figure 45: Reciprocating Compressor

Implementation Details

The existing compressor has been replaced with energy efficient screw air compressor with VFD. VSD operated screw compressor has two functions: one, it varies RPM of compressor based on pressure variation at the load or perform end and two, it also reduces no load power consumption during unloading condition by bringing the motor to a halt. Such operation prevents consumption of power during unload condition.

Merits

- ❖ Maintenance is simple in screw-based air compressors.
- ❖ By using VFD in screw air compressors, the operating pressure of air compressor can be precisely controlled.
- ❖ The leakage in the compressed air system is proportional to the operating pressure.



Cost Benefit Analysis

The expected savings by installation of energy efficient screw compressor in place of reciprocating compressor is 61,285 kWh annually. The annual monetary saving for this project is INR 4.01 Lakh with an investment of INR 9.80 Lakh and payback for the project is 29 months.

Table 47: Cost Benefit Analysis – Screw compressor in place of reciprocating compressor

Parameters	Value	UOM
Total installed capacity	4.25	m ³ /min
Actual air delivery	3.05	m ³ /min
Volumetric Efficiency	71.66	%
Input motor power	28	kW
Specific Power Consumption	9.19	kW/m ³ /min
Proposed power consumption	6	kW/m ³ /min
Reduction of power consumption	18	kW
Reduction in annual energy consumption	61,285	kWh/annum
Monitory savings	4.01	INR Lakh/annum
Investment	9.8	INR Lakh
Simple Payback period	29	Months

Energy & GHG Savings



Technology Supplier Details

Table 48: Technology supplier details – Screw air compressor

Description	Details
Supplier Name	Kaeser Compressor
Address	Sakar-9, 1105, Ashram Rd, beside Old Reserve Bank, Muslim Society, Navrangpura, Ahmedabad, Gujarat 380009
Contact Person	Mr. Jignesh
Email Id	jignesh.shah@kaeser.com
Phone No	+91-9909944506



4.3.3. Energy Conservation in Compressor by Modifying Airline System

Unit: Foundry unit, Belgaum

Baseline Scenario

The existing system is made up of metallic pipeline having a lot of joints & welds, due to which there was a lot of frictional loss & leakage, which lead to energy loss. The new pipe material has a smooth surface inside, which can minimize frictional losses. This material can be bent easily so that there is no necessity to use joiners. With the use of this material, we can minimize joints and hence avoid air leakage. This will help minimize energy consumption.



Figure 46: Existing compressed air piping



Figure 47: HDPE Aluminium Pipe-line

Implementation Details

Multilayer pipes (MLC) (Generic Name Pe-Al-Pe Pipe) are made of five layers. The inside & outside layers comprise of HDPE (High Density Polyethylene) tightly bonded with melt adhesives to intermediate layer of Aluminium Core, which is longitudinally overlapped. These pipes offer the advantages of both metal and plastic pipe, with none of their shortcomings. The working life of MLC pipes is more than 20 years.

Because the internal surface of the MLC pipes is smooth, the flow rate in these pipes is 30% more than GI Pipes. MLC Pipes are bendable and hence require a smaller number of fittings and require minimum joints. MLC Pipes are corrosion resistant and scale free. Plastic layer resist deterioration by corrosion due to moisture. There will be some friction loss in MLC pipe due to internal fittings but the overall performance of the Piping System will be better than other pipes as there are a smaller number of fittings required.

Merits

- ❖ Reduction in air leakages.
- ❖ Life cycle is more than 12 - 15 years.

Cost Benefit Analysis

The expected savings by installation HDPE aluminium piping is 0.37 Lakh kWh annually. The annual monetary saving for this project is INR 2.85 Lakh, with an investment of INR 3.50 Lakh and the payback for the project is 15 months.

Table 49: Cost benefit analysis – Aluminum pipe for compressed air

Parameters	Value	UOM
Before: 50 Hp Compressor operating		
Energy consumption per hour	37.5	kW
Energy consumption for two shift/day	600	kWh
Energy consumption for 26 working days	15,600	kWh
After Implementation: 40 Hp Compressor operating		
Energy consumption per hour	30	kW
Energy consumption for two shift/day	480	kWh
Energy consumption for 26 working days	12,480	kWh
Saving in energy/annum	37,440	kWh/annum
Saving in energy/annum	2.85	INR Lakh/annum
Investment	3.50	INR Lakh
Simple payback period	15	months

Energy & GHG Savings



Replication Potential

This technology has been adopted by the foundry unit and similar application can be done in all ceramic manufacturing units.



Technology Supplier Details

Table 50: Technology Supplier Details – HDPE Aluminium Piping

Description	Details
	Supplier – 1
Supplier Name	S R Engineers
Contact Person	Mr Rajesh
Phone No	+918688876444
Address	Chennareddy Enclave Road, Indira Nagar Colony, Shanakar Nagar, Peerzadiguda, Hyderabad, Telangana -500039
	Supplier – 2
Supplier Name	Godrej & Boyce Mfg. Co. Ltd.
E-mail	casene@godrej.com
Phone No	91-22-67962258 / 1104
Address	E & E Services – Compressed Air Management Solutions Pirojshanagar, Vikhroli, Mumbai – 400 079, India.



4.3.4. Retrofit of Energy Efficient Ceiling Fans in Place of Conventional Fans

Unit: Eros Sanitary, Shobheshwar Road, Morbi.

Baseline Details

In cast house, mould slow drying process is an essential component of sanitaryware production process. The moulds drying process takes a minimum of 12-16 hours, depending on the atmospheric conditions. The moulds are kept in storage area and are dried by air from the ceiling fans. There are close to 300 to 500 ceiling fans installed for drying purpose. The drying process leads to loss of moisture in the moulds/casting & the process has to be slow, otherwise cracks will develop in the casting. After drying, the moisture content is 1.5% to 0.5%. During this process, the ware loses its weight & and shrinks in size.

Implementation Details

The BLDC Technology or Brushless DC Motor: A BLDC fan takes in AC voltage and internally converts it into DC using SMPS. The main difference between BLDC and ordinary DC fans is the commutation method. A commutation is basically the technique of changing the direction of current in the motor for the rotational movement. In a BLDC motor, as there are no brushes, so the commutation is done by the driving algorithm in the electronics. The main advantage is that over a period of time, due to mechanical contact in a brushed motor, the commutators can undergo wear and tear. This thing is eliminated in BLDC Motor, making the motor more rugged for long-term use and also using less energy for rotation due to no mechanical contact. The expected electrical energy reduction is approximately 60% from the actual consumption. The fans are provided with timer-based remote control. This feature can be utilized for auto switching off the fan after the required process time.

Results:

- ❖ Reduced specific energy consumption for products manufactured.
- ❖ Reduced electrical bill costs by 60%.
- ❖ Increased production.

Cost Benefit Analysis

The expected energy savings to be achieved by replacement of existing ordinary fans with energy efficient BLDC fans is 0.677 Lakh kWh annually. The annual monetary saving for this project is INR 4.73 Lakh, with an investment of INR 6.3 Lakh and a payback period of 16 months.



Table 51: Cost benefit analysis – Energy efficient BLDC ceiling fan

Parameters	Value	UOM
Quantity of conventional fans	300	Units
Operating hours	16	Hrs
Energy consumption with existing fans	360	kWh
Energy consumption with BLDC fans	134.4	kWh
Energy savings	225.6	kWh
Annual energy saving	67,680	kWh/annum
Energy cost saving	4.73	INR Lakh/annum
Investment	6.30	INR Lakh
Simple payback period	16	Months

Energy & GHG Savings



Replication Potential

This method can be adopted in all other units, where a similar kind of cast house drying is done. Also, all new units & green field projects can implement this project.



Technology Supplier Details

Table 52: Technology Supplier Details – Energy efficient BLDC fan

Description	Details
	Supplier – 1
Name of Company	Atomberg
Contact Person	Mr Rohit Sharma
Designation	Manager
Contact	Mobile:+91-9980993600
Address	Ahmedabad
	Supplier – 2
Name of Company	Canfan Private Limited
Contact Person	Mr Rajesh
Designation	Manager
Contact	Mobile: +91-9372413113
Address	Pune/Chennai



4.3.5. Installation of Energy Efficient Pump

Baseline Details

The ceramic unit uses water for wet grinding in ball mill to prepare the ceramic product body raw materials. The units have borewell pumps installed for pumping raw water for use in grinding and also for other purposes. Many units are using conventional pumps with standard motors which have low operating efficiency. There exists a good potential to optimize the power consumption for raw water pumping.

Brief about the technology innovation

The S₄RM (Shakti Slip Start Synchronous Run Motor) offers one of the most energy efficient pump system. This innovation is based on incremental efficiency improvement in both i.e. pump as well as motor. The S₄RM technology-based motors are magnetic motors which are line start i.e. they do not require any VFDs to operate; thus, they are a direct replacement of conventional induction motors. The motor with this technology starts asynchronously, and runs at a synchronous speed in steady state, thereby leading to combined advantages of induction (self-start), and synchronous motor (high efficiency). This technology is implemented for both surface and submersible type of motor-pump applications.

As it is a magnet-based motor, the runtime efficiency of the S₄RM motor is 5-10% higher than that of an induction motor on account of reduction in stator copper losses and removal of rotor electrical losses. The S₄RM takes reduced starting current up to 50% as compared to other motors. It thus offers a long life of motor insulation as the starting current is lesser. Power factor is close to unity which reduces distribution losses and PFC capacitors.

The S₄RM is a retrofit energy efficient technology. The technology is available till 75 hp of power range. The overall energy consumption can be reduced to 50% in some cases. S₄RM runs at full speed irrespective of voltage and load, and therefore can improve production in industry environment.

Table 53: Comparison between conventional pump set and S₄RM pump

Parameter	Unit	Conventional pump set	S ₄ RM pump
Capacity of motor	hp	10	10
Head developed by pump	M	64	64
Discharge by pump	LPM	467	467
Motor efficiency	%	74	93.3
Pump efficiency	%	61	76
Overall efficiency of pump set	%	45.1	72.8
Input power	kW	9.0	6.71



Cost Benefit Analysis

The expected energy savings to be achieved by installation energy efficient pump is 9,108 Lakh kWh annually. The annual monetary saving for this project is INR 0.64 Lakh, with an investment of INR 1.50 Lakh, and a payback period of 28 months.

Table 54: Cost Benefits Analysis – EE Pumps

Parameter	Value	Units
Pump operating hours	12	hrs/Day
New pump power	6.71	kW
Existing pump power	9.0	kW
Energy saving	2.3	kW
Energy saving per annum	9,108	kWh
Total annual monetary savings	0.64	INR Lakh
Total investment	1.50	INR Lakh
Simple payback period	28	Months

Energy & GHG Savings



Replication Potential:

This energy efficient pump set can be installed to replace existing conventional pump sets in the entire sector.



Technology Supplier Details

Table 55: Technology Supplier Details – EE pumps

Description	Details
Name of Company	Shakti Pumps Limited
Contact Person	Mr. Kaushal Patel
Designation	BDM Gujarat
Contact	Mobile: +91-7600030825
Email ID	Kaushal.patel@shaktipumps.com
Address	501, Sarkar 5, Behind Natraj Cinema, Ashram Road, Ahmedabad – 380009



4.3.6. Installation of Energy Efficient Motors in Place of Old Rewinded Motors

Unit: Excel Ceramic Pvt Ltd, Morbi

Baseline details

The unit has installed a ball mill with 250 hp drive for grinding of raw materials. As per the process requirement, motor should run at full speed during the start of batch and after a particular time period it should rotate at less speed. The detailed assessment study of the ball mill, electricity consumption was done. The electrical motor drives associated with ball mills were found to be rewinded multiple times because of which the body temperature and electricity consumptions was observed to be very high as compared to similar size ball mill motor.

Implementation Details

IE3 standard motors will improve motor operating efficiency as compared to old rewinded motors. IE3 motors have superior efficiency and can be operated from 50% to 100% since they have flat curve than conventional motors due to:

- ❖ Increasing the mass of rotor conductors/ conductivity
- ❖ Precision air gaps to reduce current requirements
- ❖ Improved winding and lamination design to minimize power consumption

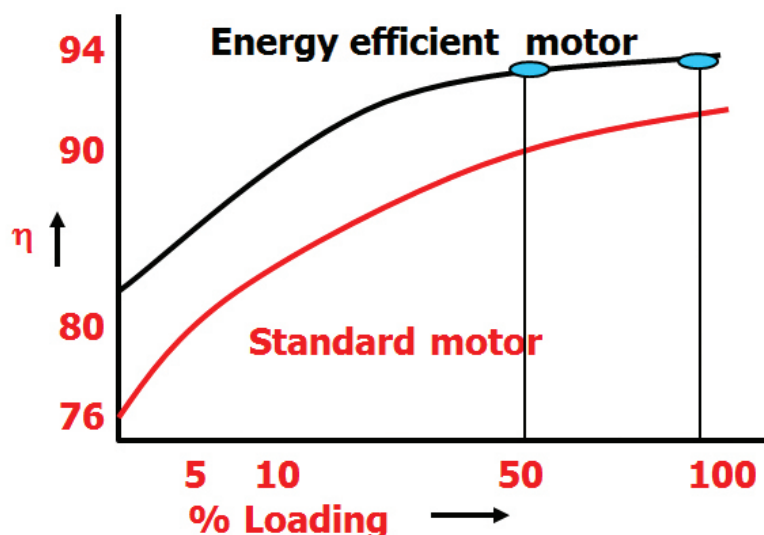

Figure 48: % loading for Energy Efficient Motors

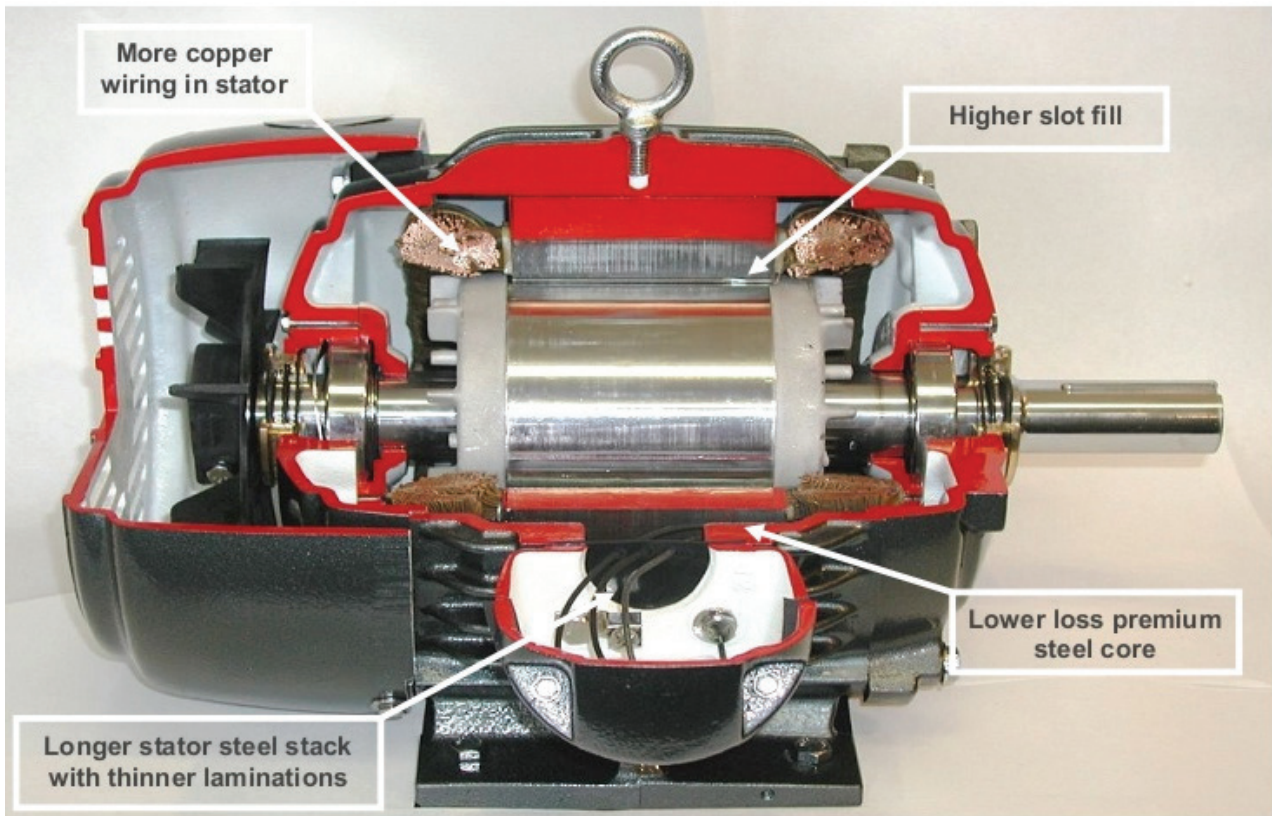

Figure 49: Energy Efficient Motors

To optimise batch timing, replace existing 200 kW rewinded motor drives with energy efficient IE3 standard motor drives of same rating. The expected electrical energy reduction is approximately 10% from the actual consumption. The electrical wiring and associated infrastructure will remain same and only motor is to be changed from the gear coupling. The belt drive is attached to the gearing arrangement for transfer of motion to the ball mill.

Results:

- ❖ Reduced specific energy consumption for products manufactured.
- ❖ Increased electrical efficiency.
- ❖ It results in reduction in GHG emissions.

Cost Benefit Analysis

The expected energy savings to be achieved by installing energy efficient motor is 1.21 Lakh KWh annually. The annual monetary saving for this project is INR 9.60 Lakh, with an investment of INR 6.50 Lakh and a payback period of 8 months.

Table 56: Cost Benefit analysis EE Motors

Parameter	Values	Units
Motor capacity	200	kW
Motor efficiency (old motor)	80	%
Motor efficiency (New IE3 motor)	95.4	%
Operating hours	3,000	Hrs
Power consumption by old motor	7,50,000	kWh/annum
Power consumption by IE3 motor	6,28,931	kWh/annum
Annual energy savings	1,21,069	kWh/annum
Annual energy savings cost	9.68	INR Lakh/annum
Investment	6.50	INR Lakh
Simple Payback Period	8 months	In Months

Energy & GHG Savings



Replication Potential

This method can be adopted in all other units where old motors are installed and rewinded more than twice. Also, all new units & green field projects can implement this project.



Technology Supplier Details

Table 57: Technology Suppliers for EE Motors

Description	Details
Name of Company	Rotomotive Drives
Contact Person	Mr Gagendra
Designation	Manager
Contact	Mobile: +91-9377511911
Address	Ahmedabad

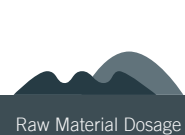

4.3.7. Transvector Nozzle for Compressed Air Sanitaryware Mould Cleaning Application

Baseline details

Utilization of compressed air for servicing application such as cleaning and drying is not uncommon and is also not a recommended practice for such applications. The service air points are being used at a pressure of 5.5 kg/cm², resulting in wastage of energy.

For instance, using cleaning air from a hose of ½” dia., at 5.5 kg/cm², the amount of air consumed is approximately 336 cfm. Considering that the compressor operates at a specific energy consumption of 0.18 kW/cfm, the total energy consumed is 60 kW/hr.

For cleaning applications, the volume of airflow is the governing factor and not the operating pressure of the compressed air. Therefore, cleaning can be effectively achieved with a low pressure compressed air as well, thereby saving significant amount of energy.

As per the standards, reduction in the delivery pressure by 1 bar in a compressor would reduce the power consumption by 6 – 10 %. As the compressor is operated a higher pressure than is required, there is a scope of saving energy.



Figure 50: Transvector Nozzle

When compressed air enters the nozzle or jet, it fills a chamber with only one exit path – a thin annular orifice. As air passes through this orifice, the venturi effect of the orifice entrains the free surrounding air as it exits. This results in increased airflow volume more than supplied by the compressed air.

Hence the required volume and pressure required for cleaning application is met by consuming minimum amount of compressed air. Results show that as much as 30 to 40% of the atmospheric air is utilized, thereby reducing the compressed air consumption, which indirectly saves load on the compressor and saves the energy consumed by the compressor.

Cost Benefit Analysis

The expected energy savings by replacing 30 nozzles would be INR 0.84 Lakh with an investment of INR 0.90 Lakh with a payback period of 12 months.



Table 58: Cost Benefit Analysis – Transvector Nozzle

Parameter	Value	Unit
Number of cleaning points considered	30	Nos.
Flow through 0.5” hose at 5.5 bar pressure (as per standard)	138	CFM
Savings in cfm consumption with per transvector nozzle	69	CFM
Present SEC (Average)	0.18	kW/CFM
Total savings per transvector nozzle	12.42	kW
Average Annual Operating hours	1,000	Hours
Annual savings	0.84	INR Lakh/annum
Investment required	0.90	INR Lakh
Simple Payback period	12	Months

Benefits and Replication potential

Application of compressed air is common in all sanitaryware mould cleaning application in sanitaryware manufacturing units and implementation of transvector nozzle can be replicated in all the production units.

Energy & GHG Savings



Technology Supplier Details

Table 59: Technology Supplier Details – Transvector Nozzle

Description	Details
Supplier Name	General Imsubs P. Ltd
Address	General Imsubs P. Ltd. 3711/A, GIDC, Phase-IV, Vatva Ahmedabad 382445, India
Contact Person	Mr. Kaushalraj
Email Id	air@giplindia.com
Phone No	+91 9327030174



4.3.8. Maximum Demand Controller for Avoiding Excess Contract Demand Penalty

Unit: ESSCE Infrastructure Pvt. Ltd., Tuticorin, Tamilnadu

Baseline details

From electricity bill it is observed that monthly average actual maximum demand on HT SC 114 is 291.55 kVA, which exceeds stipulated quota demand of 164.5 kVA. Whereas from the study it is observed that unit's average normal demand at full load operation (with all sections in load) should not go beyond 200 kVA. As a result, unit is paying demand charges @ INR 350/kVA on basic recorded kVA demand as well as excess kVA demand charges after adjustment @ INR 700/kVA. Hence, unit must pay attention more on maximum demand reduction strategy.

Proposed system

The unit has installed a new generation Maximum Demand Controller with at least four relay outputs able to disconnect non-critical loads, on different time periods and avoid connecting loads simultaneously to reduce the instantaneous power.

Non-critical loads are those that do not affect the main production process or that are not essential, such as:

- ❖ Lighting
- ❖ Compressor
- ❖ Office Air-conditioning systems
- ❖ Field Pumps
- ❖ Packaging machines
- ❖ Canteen loads

Maximum Demand Controller should incorporate an internal power analyzer for the maximum demand calculation (it also records electrical parameters such as voltage, current and power). Every time controller detects a power excess, this will disconnect several lines with non-critical loads, reducing automatically the instantaneous power. This will ensure that the installation will reduce the demand, hence reduction of penalties or excess over drawl charges beyond quota limit of electricity bill.



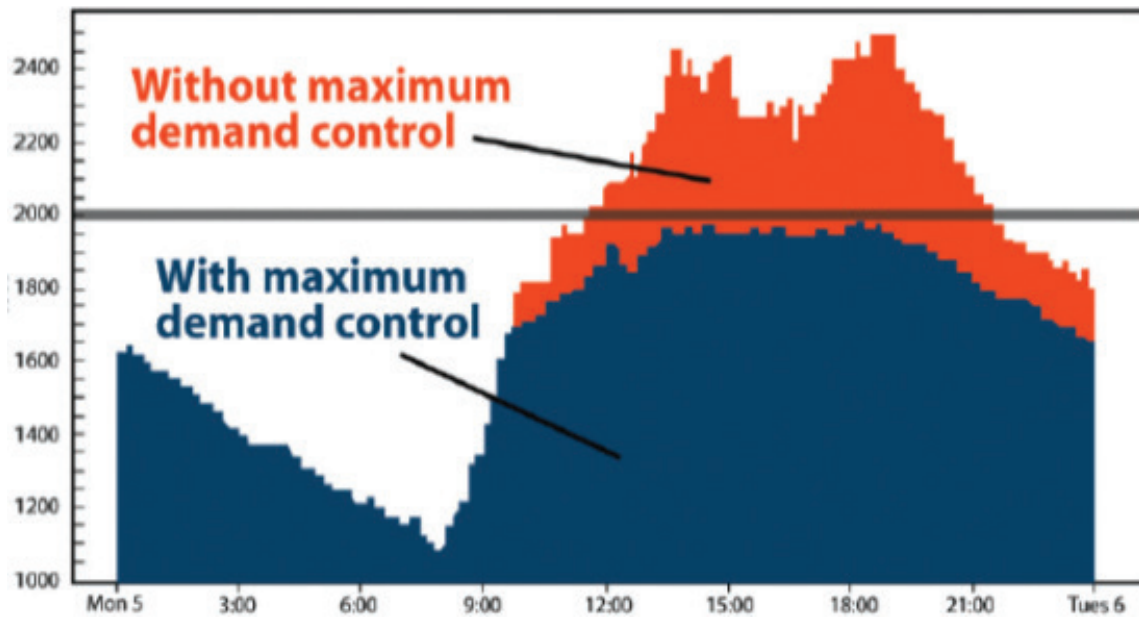

Figure 51: Demand variation with and without demand control

Cost Benefit Analysis

By installing new generation maximum demand controller cost saving potential of INR 2.30 Lakh can be achieved with an investment of INR 2.10 Lakh with a payback period of 11 months.

Table 60: Cost Benefit Analysis – Maximum Demand Controller

Parameter	Value	Unit
Excess demand	27.4	kVA
Excess Demand charges	700	INR/kVA
Annual savings	2.30	INR Lakh/annum
Investment required	2.10	INR Lakh
Simple Payback period	11	Months



Technology Supplier Details

Table 61: Technology Supplier for Maximum Demand Controller

Description	Details
	Supplier – 1
Supplier Name	Youdit Approaches Private Limited
Address	RPS Palms, Sec-88, Faridabad-121002
Contact Person	Mr. Priyaranjan Sinha
Email Id	youdit@youdit.co.in
Phone No	+91-9811456950
	Supplier – 2
Supplier Name	Tirupati Automation
Address	Shiv Plaza-2, Shop No-14 & 15, Matel Road, At- Dhuva, Ta.Wankaner, Dist. Morbi (Guj)
Contact Person	Bhavesht Vamja
Email Id	tirupatiautomation@gmail.com
Phone No	+91-9879411415 , +91-8000682152



4.3.9. Power Factor Correction & Harmonic Mitigation at Main LT Incomer

Baseline details

In the existing unit facility, due to harmonic and capacitor deration the power factor at the LT Main incomer is observed lower than 0.95 and the total harmonic distortion is observed to be 40%. Existing detuned APFC and normal APFC for reactive compensation was ineffective. Harmonics was very high at load level as well as at LT incomer. Due to reduction of power factor, the kVA billing in the unit facility increased.

Effect of Harmonics:

- ❖ Extra heating/noise of transformers
- ❖ Circuit breaker & protective relays malfunction
- ❖ Erratic operation of computers, telecommunication, video monitors & electronic test equipment
- ❖ Failure of capacitors
- ❖ De-rating of generators
- ❖ Malfunction of measuring instruments
- ❖ Overheating of motors

Proposed system

Fast acting hybrid filter solution at the main LT incomer to improve power factor and active filter for the harmonic mitigation.

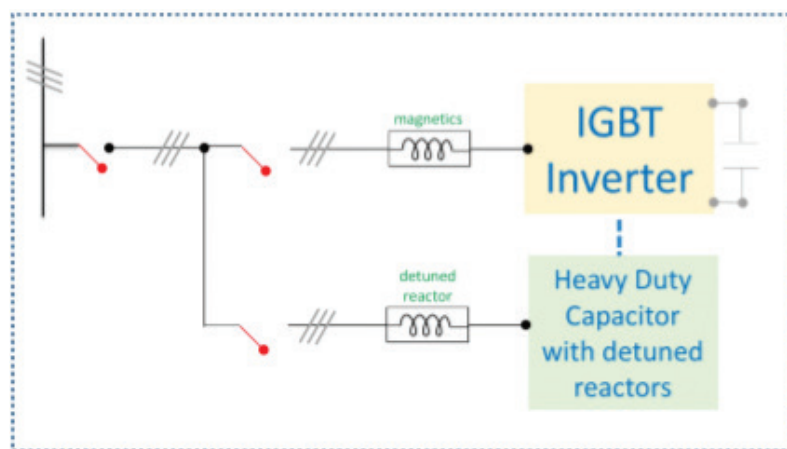

Figure 52: Operation of hybrid filter

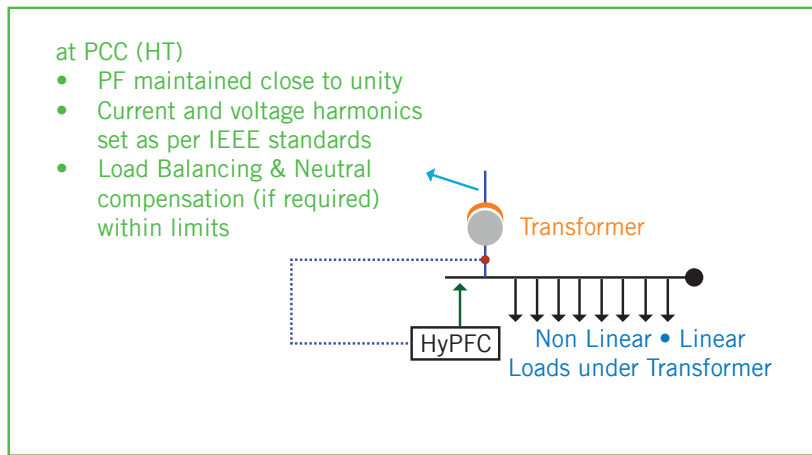

Figure 53: Connection Diagram

Hybrid power factor correction system has following advantages over conventional system (detuned APFC/RTPFC)

- ❖ Instantaneous True PF compensation up to unity
- ❖ Step less reactive compensation
- ❖ Responses in microseconds
- ❖ Leading/Lagging both compensation
- ❖ Harmonics compensation as per IEEE-519 standards
- ❖ Runs on DG as well as grid
- ❖ Maintenance free

S.No.	Feeder Name	Filter Status	Arms (A)												Power			PF Mean	dPF Mean	Reduction in kVA	Reduction in kVA (%)					
			R	Y	B	N	R	Y	B	R	Y	B	R	Y	B	kW	kVA _r					kVA				
ESS-1 Transformer (2000kVA, 11/0.433kV), HPFC (600kVA _r)																										
1	Main LT Incomer	OFF	940	884	852	83	10	10	11	8	7	8	726	300	825	0.88	0.88	99	12%							
		ON	1019	1012	986	83	7	5	7	6	5	6	726	0	726	1.00	1.00									
ESS-3 Transformer (2000kVA, 11/0.433kV), HPFC (600kVA _r)																										
2	Main LT Incomer	OFF	1147	1215	1148	8	6	6	6	4	4	4	792	309	852	0.93	0.93	60	7%							
		ON	1093	1156	1091	8	2	3	2	2	2	2	792	-18	792	1.00	1.00									
2.1	ABS Paint shop, A/F-3,	OFF	422	500	458	-	35	33	37	27	30	31	300	83	329	0.91	0.96	10	3%							
		ON	405	474	447	-	20	19	20	15	16	16	300	81	319	0.94	0.96									
ESS-4A Transformer (2000kVA, 11/0.433kV), HPFC (400kVA _r)																										
3	Main LT Incomer	OFF	1049	946	985	90	14	18	15	12	14	12	765	120	789	0.97	0.99	16	2%							
		ON	1107	1006	1045	90	5	6	5	4	5	4	765	69	773	0.99	1.00									

Figure 54: Reduction in KVA with & Without operation of Hybrid Filter

Improvement in power factor leads to reduction in kVA demand thereby reduction in energy consumption and leads to saving in cost.

Cost Benefit Analysis

By installing new generation maximum demand controller cost saving potential of INR 5.00 Lakh can be achieved with an investment of INR 4.50 Lakh with a payback period of 11 months.

Table 62: Cost Benefit Analysis – power factor improvement

Parameter	Values	UOM
Reduction in kVA	15	kVA
Operational hours	16	Hours/day
Operational days	330	Days
Annual savings	79,200	kVAh/annum
Annual monetary savings	5.00	INR Lakh/annum
Investment	4.50	INR Lakh
Simple payback period	11	Months

Technology Supplier Details

Table 63: Technology supplier details - Hybrid filter for power factor improvement

Description	Details
Supplier Name	P2P Power solutions
Address	RPS Palms, Sec-88, Faridabad-121002
Contact Person	Mr. Priyaranjan Sinha(associate)
Email Id	youdit@youdit.co.in
Phone No	+91-9811456950



4.3.10. Installation of VFD on Agitator Motor

Baseline details

The unit has installed underground tanks fitted with agitator in each tank for continuously mixing to maintain uniformity and avoid settling of solid particle. Initially when the fresh charge comes from ball mill/blunger, loading on motor is in between 60% to 75%. After some time as the raw material become uniform then loading on motor decreases, the loading on agitator motors is in between 30% to 65%. Also speed of motors is higher than the required speed for most of the time during agitation process.

Implementation Details

A variable frequency drive (VFD) is a specific type of adjustable-speed drive which controls the speed of motor according to the requirement. The speed of the agitator motor can be reduced by installing variable frequency drive and operating speed can be programmed based on time. This will result in saving in power consumption to the extent of 15% in agitation section.

Cost Benefit Analysis

The expected energy savings to be achieved by installing VFD in agitator motor drive is 0.23 Lakh kWh annually. The annual monetary saving for this project is INR 1.60 Lakh, with an investment of INR 1.20 Lakh and a payback period of 9 months.

Table 64: Cost benefit analysis – VFD in agitator motor

Parameter	Values	UOM
Motor capacity	3	hp
Agitator quantity	10	Nos
Operational hours	24	Hours/day
Operational days	330	Days
Present power consumption in agitator	1,52,460	kWh/annum
Power saving	22,869	kWh/annum
Annual monetary savings	1.60	INR Lakh/annum
Investment	1.20	INR Lakh
Simple payback period	9	Months



Energy & GHG Savings



Replication Potential

This method can be adopted in all other units. Also, all new units & green field projects can implement this project.

Technology Supplier Details

Table 65: Technology Supplier details for VFD

Description	Details
	Supplier – 1
Name of Company	Danfoss Industries Pvt Ltd
Contact Person	Mr Hiran Thakkar
Designation	Manager
Contact	Mobile: +91-7940327341
Address	Ahmedabad
	Supplier – 2
Supplier Name	Tirupati Automation
Address	Shiv Plaza-2, Shop No-14 & 15, Matel Road, At- Dhuva, Ta. Wankaner, Dist. Morbi (Guj)
Contact Person	Bhavesh Vamja
Email Id	tirupatiautomation@gmail.com
Phone No	+91-9879411415 , +91-8000682152



4.3.11. Installation of On-off Controller System in Agitator Motor

Baseline details

The unit has installed underground tanks fitted with agitator motor in each tank, for continuously mixing to maintain uniformity and avoid settling of solid particle. Initially when the fresh charge comes from ball mill/blunger, loading on motor is in between 60% to 75%. After some time as the raw material become uniform then loading on motor decreases, the loading on agitator motors is in between 30% to 65%. These motors operate for about 24 hours in a day.

Implementation Details

Installation of automatically ON – OFF control system on the agitator motors do not affect the uniformity (quality) of slurry. It results in saving in electricity consumption in agitator motors. This system automatically switches ON agitator motors for about 10 minutes and then switches OFF for about 5 minutes. This means that in one hour, agitator motors operate for about 40 minutes and remain switch off for about 20 minutes. This could result in approximately 30% saving in electricity consumption of agitator motors.

Cost Benefit Analysis

The expected energy savings to be achieved by installing on-off controller system is 0.46 Lakh kWh annually. The annual monetary saving for this project is INR 3.20 Lakh, with an investment of INR 0.50 Lakh and a payback period of 2 months.

Table 66: Cost Benefit analysis - On off controller system in agitation system

Parameter	Values	UOM
Motor capacity	3	hp
Agitator quantity	10	Nos
Operational hours	24	Hours/day
Operational days	330	Days
Present power consumption in agitator	1,52,460	kWh/annum
Power saving	45,738	kWh/annum
Annual monetary savings	3.20	INR Lakh/annum
Investment	0.50	INR Lakh
Simple payback period	2	Months



Energy & GHG Savings



Replication Potential

This method can be adopted in all other units. Also, all new units & green field projects can implement this project.

Technology Supplier Details

Table 67: Technology supplier details for on-off controller system

Description	Details
Supplier Name	Tirupati Automation
Address	Shiv Plaza-2, Shop No-14 & 15, Matel Road, At- Dhuva, Ta. Wankaner, Dist. Morbi (Guj)
Contact Person	Mr. Bhavesh Vamja
Email Id	tirupatiautomation@gmail.com
Phone No	+91-9879411415 , +91-8000682152



4.3.12. Installation of Energy Efficient Motor in Place of Existing Conventional Motors in Agitator System

Baseline details

The unit has installed underground tanks fitted with agitator motor in each tank, for continuously mixing to maintain uniformity and avoid settling of solid particle. Initially when the fresh charge comes from ball mill/blunger, loading on motor is in between 60% to 75%. After some time as the raw material become uniform then loading on motor decreases, the loading on agitator motors is in between 30% to 65%. This reduction in motor loading decreases the motor efficiency and thereby results in more electricity consumption. These motors operate for about 24 hours in a day.

Implementation Details

IE3 standard motors will improve motor operating efficiency as compared to old rewinded motors. IE3 motors have superior efficiency and can be operated from 50% to 100% since they have flat curve than conventional motors due to:

- ❖ Increasing the mass of rotor conductors/ conductivity.
- ❖ Precision air gaps to reduce current requirements.
- ❖ Improved winding and lamination design to minimize power consumption.

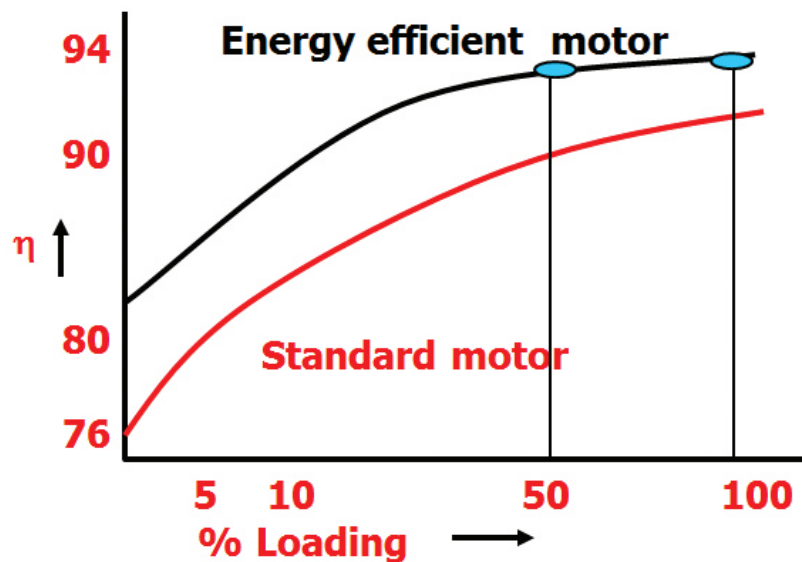

Figure 55: % loading for Energy Efficient Motors

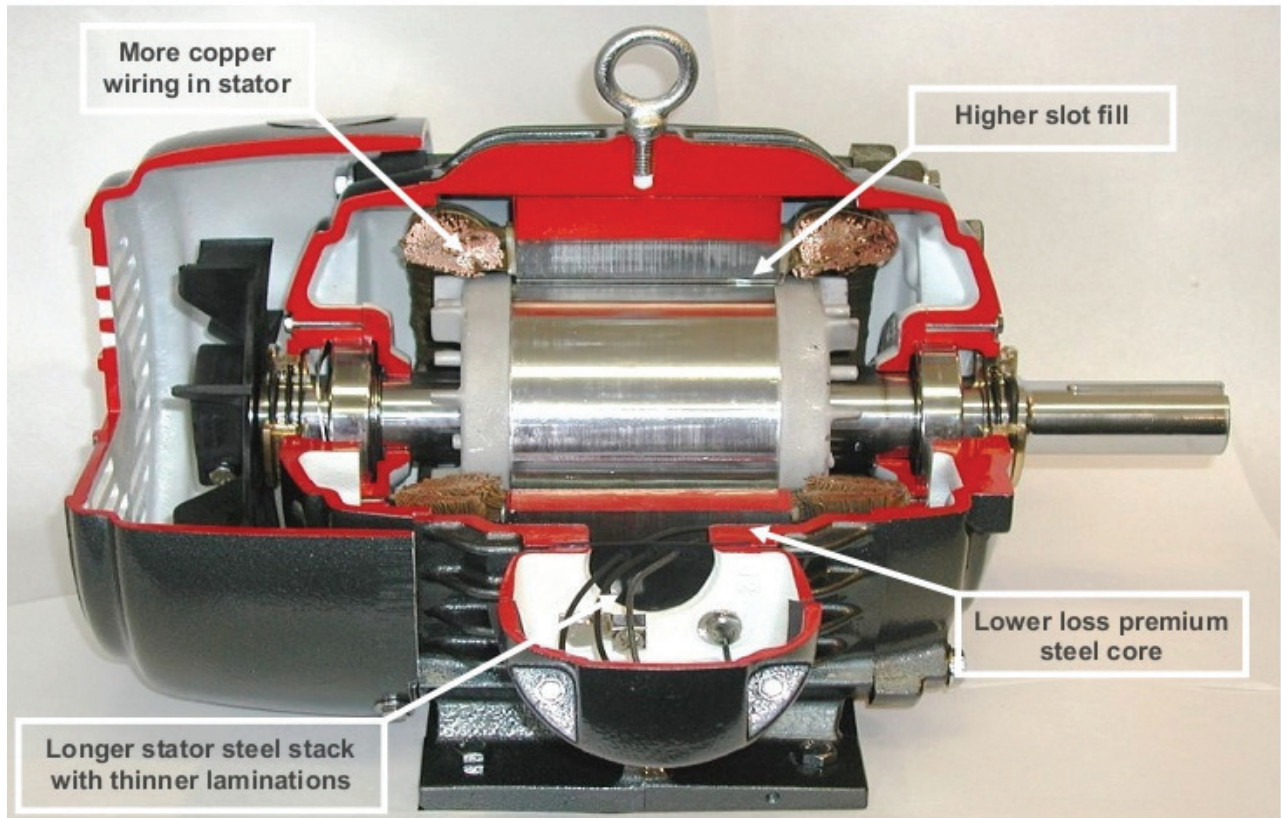

Figure 56: Energy Efficient Motors

Replacement of the existing standard efficiency motors by energy efficient motors will result in significant saving of electricity consumption in agitator motors.

Cost Benefit Analysis

The expected energy savings to be achieved by installing energy efficient motors is 11,718 kWh annually. The annual monetary saving for this project is INR 0.82 Lakh, with an investment of INR 1.25 Lakh and a payback period of 18 month.

Table 68: Cost Benefit analysis - Energy efficient motors in agitation system

Parameter	Values	Units
Motor capacity	3	hp
Agitator quantity	4	Nos
Existing Efficiency (Old motor)	80.00	%
EE motors Energy Efficiency(IE ₃)	86.70	%
Operational days	330	Days
Present power consumption in agitator	1,52,460	kWh/annum
Power saving	11,718	kWh/annum
Annual monetary savings	0.82	INR Lakh/annum



Raw Material Dosage



Body Preparation



Tile Pressing



Drying



Glazing



Printing

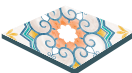

Firing

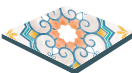

Final Output

Parameter	Values	Units
Investment	1.25	INR Lakh
Simple payback period	18	Months

Energy & GHG Savings



Replication Potential

This method can be adopted in all other units. Also, all new units & green field projects can implement this project.

Technology Supplier Details

Table 69: Technology supplier details for on-off controller system

Description	Details
	Supplier – 1
Name of Company	Rotomotive Drives
Contact Person	Mr Gagendra
Designation	Manager
Contact	Mobile: +91-9377511911
Address	Ahmedabad
	Supplier – 2
Name of Company	Siemens
Contact Person	Mr Vedavyas Nayak
Designation	Cluster head - Drives
Contact	Mobile: +91-9632077220



4.4. Case Studies in Renewable Energy

4.4.1. Solar Rooftop System

Baseline Scenario

Electricity cost constitutes 15 to 20% of total energy cost in a ceramic unit. As the ceramic units are spread across a large land area with broad sheds having significant roof areas, there is significant potential for the units to generate solar power for in-house applications through rooftop solar photo-voltaic (PV) systems. Renewable energy is deemed to be the best substitute for conventional fossil fuel. The ceramic unit has enough rooftop area which can be utilized to install solar PV for self-generation of electricity rather than purchasing from grid. A few ceramic units in Thangadh cluster have installed rooftop solar systems up to 50 kWp and are operating successfully.

The electricity generation potential at a specific location depends on the solar radiation received. The solar radiation received during each month throughout a year at Morbi is given below:

Table 70: Site Specification – For Solar PV

Parameters	
Location	Latitude: - 22.8251874, Longitude: - 70.8490809
Direct Normal Irradiance	5.78 kWh/m ² /day
Wind	3.54 m/sec
Humidity	67%

The following graphs highlights solar irradiance:

Morbi, Gujarat, India

Latitude : 22.85 Longitude : 70.85

Annual Average : 5.78 kWh/m²/day

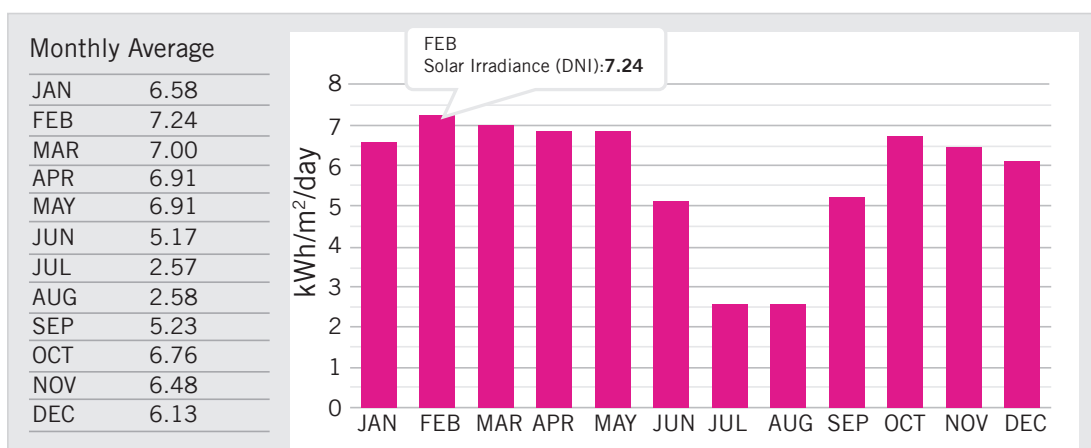

Figure 57: Solar Irradiance



Proposed System

As per the site specifications, the unit has a potential of installing 50 kWp solar rooftop which can generate around 0.80 Lakh units of electricity annually. The proposed system will be a grid-tied solar PV power unit consisting solar PV array, module mounting structure, power conditioning unit (PCU) consisting of maximum power point tracker (MPPT), inverter and controls & protections, interconnect cables, junction boxes, distribution boxes and switches. PV Array is mounted on a suitable structure. Grid-tied solar PV system is without battery and should be designed with necessary features to supplement the grid power during daytime. In grid-connected rooftop or small solar PV system, the DC power generated from solar PV panel is converted to AC power using power converter and is fed to the grid either of 33 kV/11 kV three phase lines or of 440V/220V three/single phase line, depending on the local technical and legal requirements.

These systems generate power during the daytime, which is utilized by powering captive loads and feeding excess power to the grid. In case the power generated is not sufficient, the captive loads are served by drawing power from the grid.

Net Metering Business Model – The net metering-based rooftop solar projects facilitate the self-consumption of electricity generated by the rooftop project and allow for feeding the surplus into the grid network of the distribution by the licensee. The type of ownership structure for installation of such net metering-based rooftop solar systems becomes an important parameter for defining the different rooftop solar models. In a grid-connected rooftop photovoltaic power station, the generated electricity can sometimes be sold to the servicing electric utility for use elsewhere in the grid. This arrangement provides payback on the investment of the installer. Many consumers from across the world are switching to this mechanism owing to the revenue yield.

A commission usually sets the rate that the utility pays for this electricity, which could be at the retail rate or the lower wholesale rate, greatly affecting solar power payback and installation demand. The features/ requirements for grid-connected rooftop solar PV system are as follows:

Table 71: Features/requirements for Grid Connected Solar PV Systems (Rooftop)

S. No.	Features / Requirements	Values
1	Shadow free roof area required	10 sq. m or 100 sq. ft. per kWp
2	Roof suitable for Solar PV system	Concrete/ GI/ tin shed (Asbestos may not be suitable)
3	Orientation of the roof	South facing roof is most suitable. Installation may not be feasible beyond 5 deg slope.
4	Module installation	Modules are installed facing South. Inclination of modules should be equal closer to the latitude of the location for maximum energy generation.



S. No.	Features / Requirements	Values
5	Cost of the rooftop solar PV system	<p>MNRE issues benchmark cost for GCRT SPV system and the cost for general category states for 2019-20 are as follows. This includes cost of the equipment, installation and O&M services for a period of 5 years.</p> <p>Above 1 kWp and up to 10 kWp: INR 54,000/ kWp Above 10 kWp and up to 100 kWp: INR 48,000/ kWp Above 100 kWp and up to 500 kWp: /INR 45,000/ kWp</p> <p>Based on discussions with a few project developers, average cost of the system (as per market conditions) is as follows: For 10 kWp system, INR 49,000/ kWp For 50 kWp system, INR 42,500/ kWp For 100 kWp system, INR 37,000/ kWp</p>
6	Useful life of the system	25 years
7	Annual energy generation from Rooftop Solar PV system	<p>18% CUF in 1st year, i.e., 1,578 kWh/ kWp / year 0.7% degradation every year for the useful life of the system. On an average, 1,452 kWh/ kWp/ year would be generated over the useful life.</p>

Merits

- ❖ PV panels provide clean & green energy. During electricity generation with PV panels, there is no harmful greenhouse gas emissions.
- ❖ Technology development in solar power industry is constantly advancing, which can result in lower installation costs in the future.
- ❖ PV panels have no mechanically moving parts, except in cases of sun-tracking mechanical bases; consequently, they have far less breakages or require less maintenance than other renewable energy systems (e.g. wind turbines).

Limitations

- ❖ The initial cost of purchasing a solar PV system is high, which includes paying for solar panels, inverter, batteries and wiring and for the installation.
- ❖ Although solar energy can be still collected during cloudy and rainy days, the efficiency of the system drops, which results in lower generation of energy.
- ❖ Installing a large PV system takes up a lot of space.



Cost Benefit Analysis

The expected savings by installation of 50 kWp solar rooftop is 0.80 Lakh kWh annually. The annual monetary saving for this project is INR 5.60 Lakh, with an investment of INR 18.50 Lakh and a payback period of 40 months.

Table 72: Cost Benefit Analysis – Solar PV Systems

Parameters	Value	UOM
Proposed roof top solar installation	50	kW
Annual units generation per kW of solar PV	1,600	kWh per kW/annum
Total energy generation per annum	80,000	kWh/annum
Electricity cost	7	INR/kWh
Cost savings	5.60	INR Lakh/annum
Investment	18.50	INR Lakh
Simple payback period	40	Months

Energy & GHG Savings



Technology Supplier Details

Table 73: Technology Supplier Details for Solar Rooftop System

Description	Details
	Supplier – 1
Name of Company	Raijin Solar Energy
Contact Person	Mr Jaydip Agrawat
Designation	Managing Director
Contact	Mobile: +91-9574511117
Address	Ahmedabad
	Supplier – 2
Name of Company	Mysun Solar
Contact Person	Mr Pravin
Designation	Manager
Contact	Mobile: +91-9890285988
Address	Ahmedabad



4.5. New and Innovative Technologies

4.5.1. Solar-Wind Hybrid System

Baseline Scenario

Renewable energy is deemed to be the best substitute for conventional fossil fuel. Implementation of renewable energy posts various challenges, such as capital cost and consistency of power output, of which the latter can be solved by the installation of a Solar – Wind hybrid system. The ceramic units has enough rooftop area which can be utilized to install a solar-wind hybrid system that can harness solar energy and wind energy to generate electricity.

Proposed System

The Solar – Wind Hybrid system is also known as solar mill. The solar mill generates:

- ❖ Daytime energy from the sun and wind.
- ❖ Day & night energy from the wind energy.
- ❖ Energy even on cloudy days.
- ❖ More energy on hot sunny days due to cooling effect on solar panels by wind.



Figure 58: Solar wind hybrid system

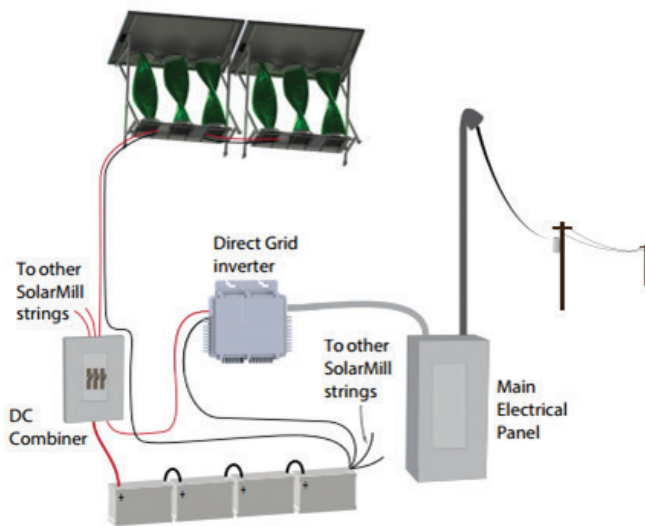

Figure 59: Hybrid mill connected to supply

Specifications

The increase of renewable power per square foot of roof is obtained by combining two power sources. For a rooftop installation, combining solar and wind power is a complementary combination. For example, many locations are less windy in the middle of the day when the sun is at its peak and the wind picks up after dusk. Other advantages are solar module providing protection for the wind portions of the mechanism from direct rain and hail and assisting with the direction of air into the turbines.

Since this compact installation is designed for rooftops and urban atmosphere, savonous type of wind turbine is chosen for its low running speed and relative insensitivity to turbulence. Power generation begins at a wind speed of 5 kmph. Independent MPPT for both wind and solar is calibrated. Maximum power point tracking (MPPT) is an algorithm included in charge controllers used for extracting maximum available power. The power from both wind and solar generation is routed into a common 48V DC bus which has built-in charge control for a lead acid battery bank.

Modes of Use

In grid-tied system, the bank of batteries is connected to one or more Direct Grid micro-inverters, which connect to the user's electrical panel. The inverters push power back to the grid efficiently when the batteries become fully charged.

It consists of three vertical axis wind turbines coupled to three permanent magnet generators. Automatic mechanical braking is provided once the wind speed goes beyond the cut-off speed. On-board smart electronics include dynamic Maximum Power Point Tracking (MPPT). It uses wind and solar resources on a 24/7/365 basis, allowing access to energy and very little interruption of services. The design life of solar mill is 25 years.

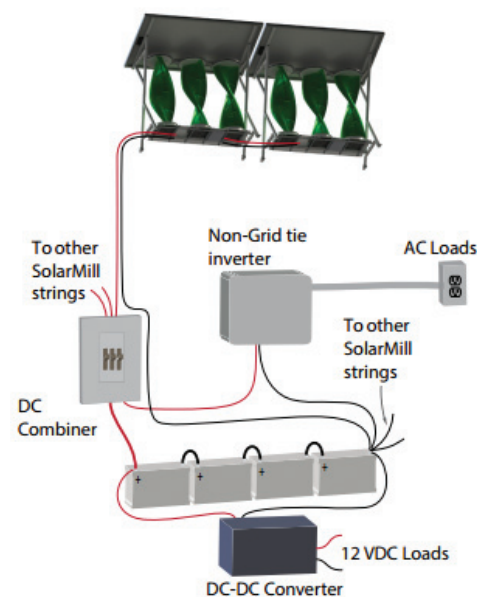

Figure 60: Hybrid mill connected to loads



In off-grid storage, the batteries can be used to supply power to electrical devices in off grid settings. This electrical energy can power DC powered devices through a voltage converter, or can power AC devices through an inverter.

Merits

- ❖ Power generation during daytime as well as night-time.
- ❖ Reliable power generation even on cloudy days.
- ❖ A compact hybrid solar mill to meet a portion of the unit's load after detailed study with vendors.
- ❖ Power generation starts at 2-5 m/s and mechanical braking occurs beyond 18 m/s.
- ❖ The power generation can be monitored online.

Limitations

- ❖ Higher investment.

Cost Benefit Analysis

The expected savings in electrical energy to be achieved by installation of a 50 kWp Solar - Wind hybrid system is 1.09 Lakh kWh units annually. The annual monetary saving for this project is INR 7.11 Lakh, with an investment of INR 50.00 Lakh and a payback period of 84 months.

Table 74: Cost Benefit Analysis – Solar Wind Hybrid Systems

Parameters	Value	UOM
Installed capacity of solar-wind Mill	50	kWp
Average generation per day per kWp	6.0	kWh
Area required	60	m ²
Annual operating days	365	Days
Electricity tariff	6.5	INR/kWh
Average annual energy saving on conservative basis	1,09,500	kWh
Annual cost savings	7.11	INR Lakh/annum
Investment	50	INR Lakh
Simple payback period	84	Months



Energy & GHG Savings



Technology Supplier Details

Table 75: Technology Supplier Details – Solar-Wind Hybrid Systems

Description	Details
Supplier Name	Windstream Technologies
Address	G2-SSH Pride, Plot 273, Road No-78, Jubilee Hills, Hyderabad 500096
Contact Person	Mr. Bhaskar Sriram
Email Id	bhaskars@windstream-inc.com
Phone No	+91 99599 18782



4.5.2. Implementation of CFD Analysis for Improving Heat Transfer in Spray Dryer

Baseline Scenario

Moisture which is added in the grinding process in the ball mill is removed in spray dryers. Hot flue gases at 550–600°C from heat source fired from lignite, Indonesian coal and biomass reduces the moisture from 35–40% in input slurry to 5–7% in output slurry.

Improper design of spray dryer and/or improper mixing of the hot gas and materials results in excess fuel consumption in spray dryer. The fuel consumption in spray dryer can be optimized/reduced by conducting the CFD study and retrofitting the system as per the CFD study analysis.

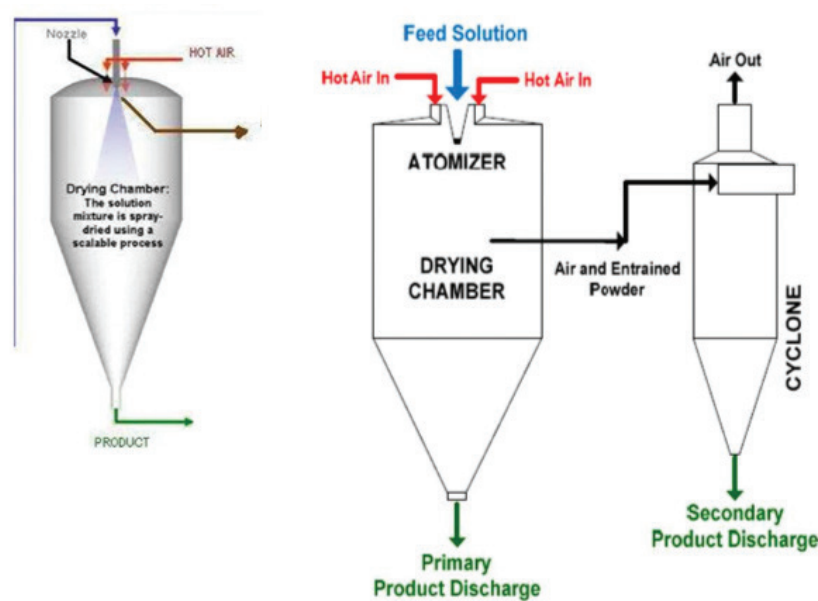

Figure 61: Spray Drying Process

Implementation Details

Computational fluid dynamics (CFD) is one of the branches of fluid mechanics that uses numerical methods and algorithms to solve and analyze problems that involve fluid flows. Computers are used to perform the millions of calculations required to simulate the interaction of fluids and gases with the surfaces used in engineering. CFD analysis could be employed to pinpoint high pressure drop zones in ducts.

CFD predicts fluid flow with the complications of simultaneous flow of heat, mass transfer, phase change and chemical reaction, etc. using set of certain CFD software and calculations.

With the rapid advancement in computers, computational fluid dynamics is used across the world in all industries for validating designs, troubleshooting, maintenance and upgrading so that they operate safely and at peak efficiencies with optimum cost.

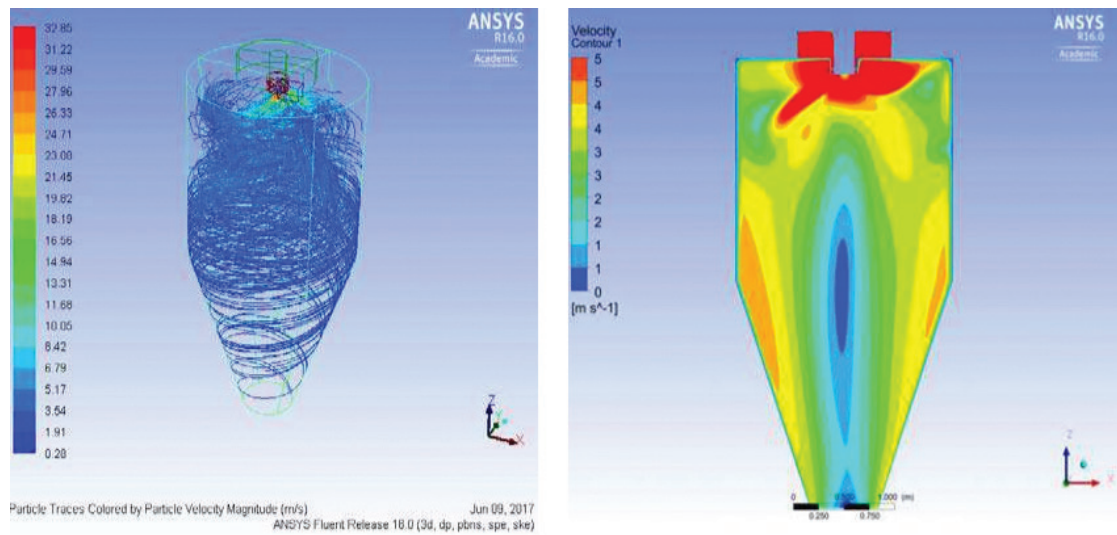

Figure 62: Particle flow pattern and velocity distribution inside the chamber

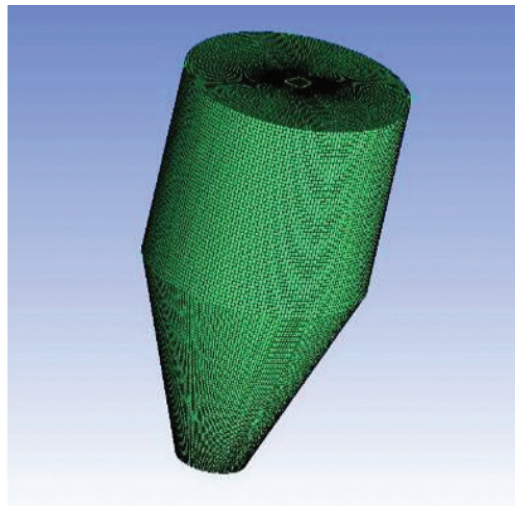

Figure 63: CFD Model of main drying chamber

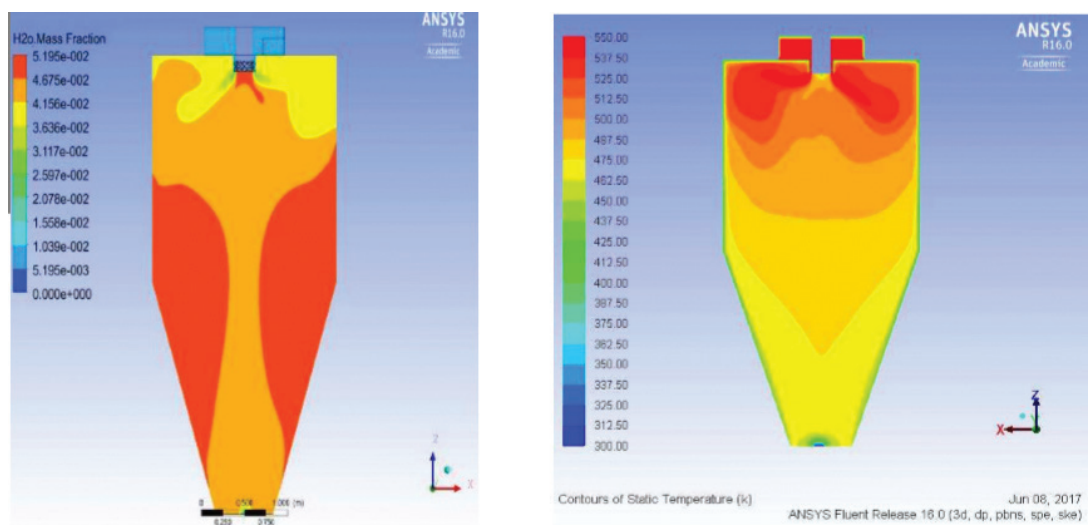

Figure 64: Contours of moisture concentration and temperature distribution inside the chamber

Working Principle

The most fundamental consideration in CFD is building and analyzing a flow model. It includes building the model within a computer-aided design (CAD) package, creating and applying a suitable computational mesh and entering the flow boundary conditions, operating conditions and fluid materials properties. The software will provide us with images and data, which predict the performance of that design.

Benefits in Ceramic units

- ❖ Particle distribution is very important for effective heat and mass transfer.
- ❖ With the help of CFD, modifications can be suggested to improve particle distributions inside the chamber.
- ❖ Uniform gas flow.
- ❖ Improved heat transfer will result in energy savings.

Cost Benefit Analysis

The expected energy savings to be achieved by conducting CFD study for spray dryer is 5,339 Lakh kCal annually. The annual monetary saving for this project is INR 6.00 Lakh, with an investment of INR 8.00 Lakh and a payback period of 16 months.

Table 76: Cost benefit analysis – CFD on Spray dryer

Parameter	Values	Units
Fuel (coal) saving	363	kg /day
GCV of fuel (coal)	4,500	kCal/kg
Total working days	330	days
Fuel cost	5	INR/kg
Annual Monetary savings (INR 7/ kWh)	6.00	INR Lakh/ annum
Investment	8.00	INR Lakh
Simple Payback Period	16	Months



Energy & GHG Savings



Replication Potential

This method can be adopted in all other units. Also, all new units & green field projects can implement this project.

Technology Supplier Details

Table 77: Technology Supplier Details – CFD Analysis

Description	Details
Name of Company	Mechwell Industries Limited
Contact Person	Mr Akshay Shah
Designation	Manager
Contact	Mobile: +91-8275016434
Address	Pune



4.5.3. Hydroxy Gas Combustion in Kiln Firing in Roller Kiln

Baseline Scenario

Ceramic tiles industries are high energy consuming industries mainly thermal energy. More than 35-40% of total cost is energy cost in ceramic tiles industries. Most energy consuming process is the firing process or kiln process. The primary energy use in ceramic manufacturing is for kiln. Natural gas is used for most drying and firing operations. Nearly 30% of the energy consumed is used for drying and over 60% of the energy consumed is used for firing.

Kiln performance is directly related to the temperature maintained & thermal efficiency at various zones of kilns. Hydroxy Gas Generator (HHO) can be used to save 10–15% of fossil fuel consumption without altering the existing system.

Implementation Details

Hydroxy gas is the combination of hydrogen and oxygen gas produced from the electrolysis of water. HHO system is composed of HHO gas unit and hydroxy system combustion system (boiler, furnace etc.). The water fuelization system converts the water into hydroxy gas and makes thermal energy. From the Hydroxy gas, the heat generation device will convert into water energy which has calorific value of 2.56 kCal/Litre.

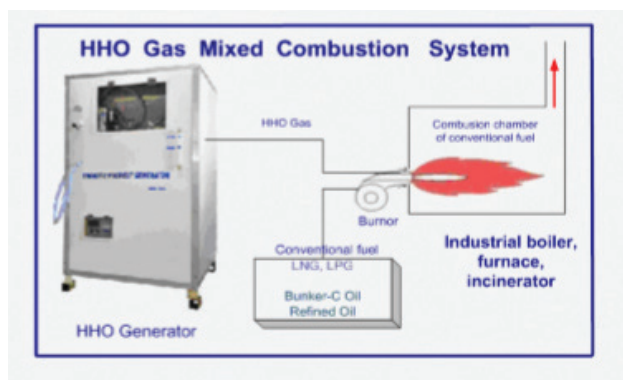

The ceramic unit can have hydroxy mixed combustion system (min 5% of total energy) to mix with Natural gas in kiln firing and burn Hydroxy Gas with conventional fuel to achieve fuel savings. Hydroxy Gas Generator unit supplies Hydroxy Gas 24 hours into the combustion chamber of existing facility. The Hydroxy Gas is mixed with conventional fuel and burned together. This can result in saving of 5-10% in fuel consumption.

Figure 65: HHO Gas Generator

Cost Benefit Analysis

The expected energy savings to be achieved by installing HHO system is 10,334 Lakh kCal annually. The annual monetary saving for this project is INR 33.51 Lakh, with an investment of INR 80 Lakh and a payback period of 28 months.



Table 78: Cost Benefit Analysis for Hydroxy Gas Combustion System in Kiln Firing

Parameter	Value	UOM
Natural gas consumption before intervention	8,500	SCM/Day
Operational hours	24	Hours /Day
Operational days	330	Days/annum
Natural gas consumption after implementation of intervention	8,160	SCM/day
Annual gas savings due to implementation of measure	1,11,720	SCM/annum
Cost of natural gas	30	INR/SCM
Total thermal energy cost savings per annum	33.51	INR Lakh/annum
Total investment required to implement this measure	80.00	INR Lakh
Simple payback period	28	Months

Energy & GHG Savings



Replication Potential

This method can be adopted in all other units. Also, all new units & green field projects can implement this project.

Technology Supplier Details

Table 79: Technology Supplier Details – Hydroxy Gas Generator System

Description	Details
Name of Company	Kankyo Group
Email:	infor@kankyo.global
Contact number	+91-9150001111
Address	No.11, Ayyavu Street, Ayyavu colony, Amminijikarai, Chennai



4.5.4. Installation of Energy Efficient burners in place of existing old conventional burners in kiln firing

Baseline details

In ceramic unit, kilns are the major source of fuel consumption. Natural gas is used mainly in kiln firing operations. Kiln performance is directly related to the temperature maintained & thermal efficiency at various zones in the kilns. In most of the ceramic units, conventional burners are used for fuel firing in kiln and there is no proper air flow control mechanism for maintaining proper combustion of fuel. The thermal efficiency of the kiln can be improved using high velocity burners. High velocity burners are better for tunnel and shuttle kiln wherein temperature uniformity is important.

About the technology

High velocity burners:

High velocity burners find application where the temperature uniformity within the job is very important for their quality and to have re-circulation of combustion gases.

Energy efficient high velocity burner is characterised with uniform and high flame length. Ceramic product requires temperature uniformly in entire job. High velocity burner with excess air control system can provide the uniform heat transfer for entire job, thereby increasing the quality of ware and efficiency of kiln.

In a kiln, the re-circulation of products of combustion can substantially contribute to the speed of heating and temperature uniformity. For low temperature ovens and dryers, suitable re-circulating fans are generally provided to achieve temperature uniformity. However, fans are not practical for high temperature furnaces and kilns.



Figure 66: High velocity burner



Figure 67: High Velocity Burner with Flame

Excess air can help in re-circulation, but this will result in wastage of fuel. 30% excess air for a 1,100°C kiln will require an additional 24% fuel than stoichiometric firing. In comparison, high velocity gases entrain and re-circulate more than seven times of its own volume will eliminate the need for fans or excess air.

Features of high velocity burners

- ❖ 300 to 1,650°C operating temperatures
- ❖ Inherently low emissions
- ❖ 18,000 to 500,000 kCal/hr capacity range
- ❖ 300°C preheated air
- ❖ Wide air/fuel ratio flexibility



Figure 68: Perfect combustion with correct air fuel to ratio



Figure 69: Improper air to fuel ratio

It is recommended to install the high velocity burner with precise control system for air to fuel ratio resulting in increasing the combustion efficiency and utilizing the heat uniformly through entire raw ware. 3-7% of fuel savings can be achieved.

Results:

- ❖ Reduced specific energy consumption in kiln
- ❖ Increased thermal efficiency
- ❖ Reduced fuel (natural gas) costs by 3-7%.

Cost Benefit Analysis

The expected energy savings to be achieved by using high velocity burners in kiln is 1,827 Lakh kCal annually. The annual monetary saving for this project is INR 6.10 Lakh, with an investment of INR 15.00 Lakh and a payback period of 30 months.



Table 80: Cost benefit analysis – Energy efficient burner

Parameter	Value	UOM
Production	14	Tonne/day
Natural gas consumption before intervention	1,540	SCM/Day
Operational hours	24	Hours/Day
Operational days	330	Days/annum
Natural gas consumption after implementation of intervention	1,478	SCM/day
Annual gas savings due to implementation of measure	20,328	SCM/annum
Cost of natural gas	30	INR/SCM
Annual monetary saving	6.09	INR Lakh/annum
Investment	15.00	INR Lakh
Simple payback period	30	Months

Energy & GHG Savings



Technology Supplier Detail

Table 81: Technology supplier details – Energy Efficient Burner

Description	Details
Name of Company	Wesman Thermal Engineering
Contact Person	Mr Tushar Shah
Designation	General Manager
Contact	+91 9879206992
Address	A-442, Sakar-VII Nehru Bridge Corner, Ashram Road, Ahmedabad 380009 T: +91 (79) 40070474



4.5.5. Optimization of water consumption by installation of water softener unit

Baseline details

Water is used for slurry preparation and in tile polishing section in ceramic units. Batch timing and resource consumption (water, electricity and fuel) depends on the water quality. Poor quality of water increases the batch timing and resource consumption. Generally the TDS of bore well water is very high. Use of high TDS water for slurry preparation results in higher consumption of water & power per batch of slurry. As the moisture content in slurry increases, due to more TDS, it requires more time and higher coal consumption for drying in spray dryer in tiles manufacturing units. The high TDS of water can be controlled by installing softener unit, which will enable resource savings.

Bore well water is having TDS level of 1,200 to 1,500 ppm which can be improved by installing softener unit which may reduce TDS level to less than 500 ppm.

About the technology

Industrial water softener:

The correct balance of minerals of incoming water to industrial systems is essential to the proper operation and maintenance of expensive equipment. It is also imperative to provide a consistent finished product. Industrial water softeners remove excess minerals, such as calcium and magnesium, to a specified and monitored level to continue the industrial process. The process of industrial water purification and softening, takes water that is unfit for industrial use, and turns it into water that is free of sediment and contaminants, with the correct pH balance.



Figure 70: Water softener unit

The system of water softening for industrial purposes requires the incoming water to travel through a porous resin bed. This resin has the appearance and consistency of tiny plastic beads. These fine beads have been constructed and treated so that each tiny bead is exceptionally porous. The surface area is also permanently chemically altered to be highly attractive to the offending minerals. The surface sites of the resin have an affinity for minerals that have an electron charge of positive two and higher, such as calcium and magnesium. Other minerals with a similar valence may also be removed. A complete analysis of the incoming water is essential to the proper operation of the water softening system.

Incoming water enters the water softener vessel that is filled with the resin bed. The velocity of the water slows, spreading over the wider surface area of the bed, and travels through



the millions of tiny beads. During this process, the minerals in the water are attracted to the resin surface areas. The water then exits the resin bed – freed of the laden minerals with little significant hydraulic head pressure drop. The resin bed captures the hardness minerals in the water. However, as the surface area of each bed in the resin is occupied by minerals, the effectiveness of the water softener gradually declines. A complete industrial water softening system has to include equipment to regenerate these resin beds. Usually, there is a duplicate resin bed that can be engaged, so that the initial resin bed has time to refresh. After water is diverted to the second bed, the regeneration of the first bed can be commenced.

The alternative is to shut off the outflowing water during the regeneration process. This may be possible if softened water demand is limited to one or two shifts only.

The resin has a much higher affinity for calcium and magnesium ions, but it will ‘give up’ those when rinsed with water containing a very high concentration of sodium ions (i.e., very ‘salty’ water) and the sodium ions replace calcium and magnesium ions on the resin. Finally, the resin bed is flushed with water to remove excess salt before the bed is placed back into service.

Benefit

Expected benefits of using low TDS water for slurry preparation:

- ❖ Water saving – 5 to 10%
- ❖ Power saving – 2 to 3%
- ❖ Fuel saving – 15 to 20% (in spray dryer)
- ❖ Chemicals saving – 15 to 20%

Cost Benefit Analysis

The expected energy savings to be achieved by using soft water – TDS less than 400 ppm – is 14,685 kCal/annum and 6,600 kWh/annum. The annual energy saving for this project is INR 18.0 Lakh, with an investment of INR 40.00 Lakh and a payback period of 26 months.

Table 82: Cost benefit analysis – Improved water quality in ball mill

Parameter	Existing	New	UOM
TDS of water	1,200	400	Ppm
Water used per batch	18	15.3	m ³ /batch
Electricity consumption per batch	141	137	kWh/batch
Total batches per day	5	5	No./day
Annual operating days	330	330	Days/annum
Electricity consumption per annum	2,32,650	2,26,050	kWh/annum



Parameter	Existing	New	UOM
Coal consumption in spray dryer	1,958	1,664	Tonnes/annum
Power cost	8	8	INR/kWh
Coal cost	6	6	INR/kg
Total annual energy saving*		18.0	INR/annum
Investment		40.0	INR Lakh
Simple payback period		26	Months

* Only energy savings is considered. Chemical savings are not considered. Chemical savings will be in the range of 15 to 20%.

Energy & GHG Savings



Technology Supplier Details

Table 83: Supplier details – Industrial water softener

Description	Details
Name of Company	Aqua Filsep Inc
Email	inquiry@aquafilsep.com
Contact	Tel :+91 79 26580047 Mobile : +91-9825048142
Address	A1/I, Chinubhai Tower, Ashram Road, Ahmedabad – 380 009



4.5.6. Installation of Energy Management System

Baseline details

The energy cost in a ceramic unit accounts for 25-30% of total production cost. In ceramic unit, kilns are the major source of fuel consumption. Natural gas is used mainly in kiln firing and dryer operations. Electrical energy is used for the operation of spray dryer, ball mills, compressor, agitators, cast section & kiln auxiliaries. Monitoring the energy use at various equipment will provide feedback and measurement of energy consumption, patterns, trends and will help in identifying opportunity areas in order to reduce energy usage and costs.

Hence for monitoring the consumption of natural gas and electrical energy, ceramic units can install an energy management system and can optimize the energy cost.

About the technology

Energy management system provides the means to controlling and reducing the energy consumption. Installation of energy management system at unit level will monitor the energy consumed by various machines. From this, the benchmark energy consumption can be set with respect to production for the machines. If an increase in energy consumption is noticed for any machine, then the reasons for the increased consumption can be diagnosed and proper remedial actions can be taken.

The energy management system involves metering, data collection, data analysis and interpretation of energy consumption. For measurement of electrical energy multiple energy meters to be installed at various sections like ball mill, slip preparation, cast house and compressor room. Online gas flow can be installed in kiln and dryer for measurement of natural gas consumption in the kiln. Energy management system communicates with multiple energy meters and online gas flow meter installed at site location.

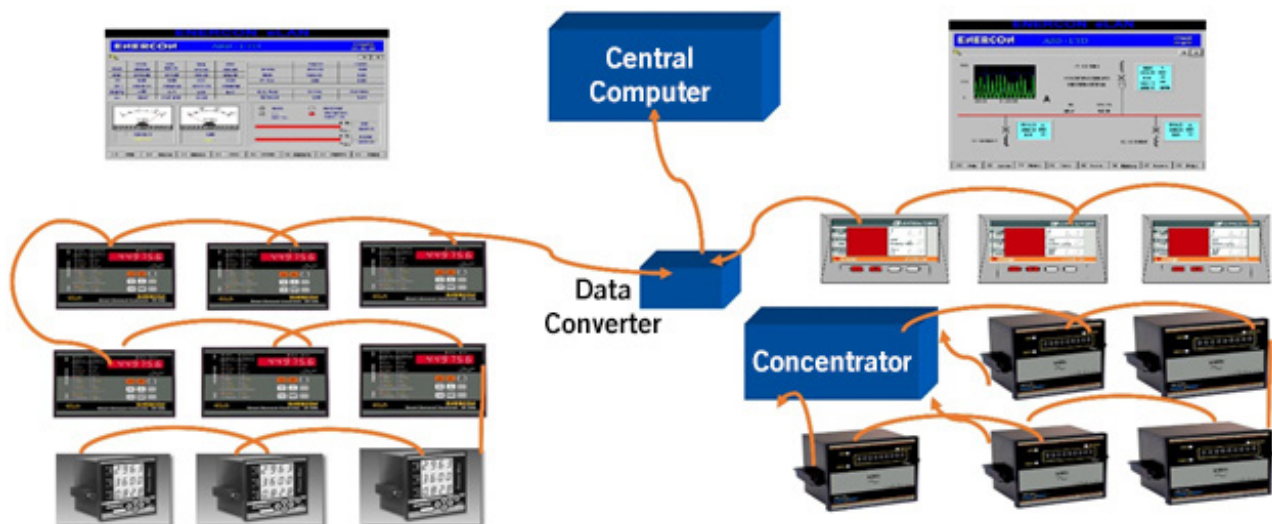

Figure 71: Components of Energy Management System

Implementation of Energy Management System provides the following benefits:

- ❖ Identification and assessment of application and consumption and prioritizing in those areas identified as high consumers.
- ❖ Identification and prioritization of savings opportunities by comparison of economic variables such as initial investment required and the payback period.
- ❖ Defining the baseline energy consumption by comparing the energy performance of the unit before and after initiating the energy management system.
- ❖ Analyzing the trend of energy consumption using the system data and, analyze the performance of the unit in achieving the energy objectives and also establish future energy goals and programs

Results:

- ❖ Reduced specific energy consumption in unit
- ❖ Reduced energy cost by 2- 3% from present levels

Cost Benefit Analysis

The expected energy savings to be achieved by installing the energy management system is 12,015 Lakh kCal & 2.18 Lakh kWh annually. The annual monetary saving for this project is INR 45.00 Lakh, with an investment of INR 12.00 Lakh and a payback period of 3 months.

Table 84: Cost benefit analysis – Energy Management System

Parameter	Value	UOM
Natural gas consumption before intervention	3,759,801	SCM /annum
Operational hours	24	Hours /day
Operational days	330	Days/annum
Natural gas consumption after implementation of intervention	3,684,605	SCM/annum
Annual gas savings due to implementation of measure	75,196	SCM/annum
Cost of natural gas	30	INR/SCM
Electrical energy (kWh) before intervention	10,944,390	kWh/annum
Electrical energy (kWh) after implementation	10,725,502	kWh/annum
Annual electrical energy savings due to implementation of measure	218,888	kWh/annum
Coal consumption in HAG before intervention	6,572,850	kg/annum
Coal consumption in HAG after implementation	6,441,393	kg/annum
Annual coal consumption savings	1,31,457	kg/annum



Parameter	Value	UOM
Total annual monetary saving	45.00	INR Lakh/annum
Investment	12.00	INR Lakh
Simple payback period	3	Months

Energy & GHG Savings



Technology Supplier Details

Table 85: Technology supplier details – Energy Management System

Description	Details
	Supplier – 1
Name of Company	Elmeasure India Pvt Ltd
Contact Person	Mr Akash
Designation	General Manager
Contact	Mobile: +918866098020
Address	Ahmedabad, Gujarat
	Supplier – 2
Name of Company	Smart Joules Pvt Ltd
Contact Person	Mr. Akshay Pandey
Designation	General Manager
Contact	Mobile: +919958768838
Address	B-98, Lower Ground Floor, Defence Colony, New Delhi, Delhi 110024



4.5.7. Insulation improvement in Hot air generator for spray dryer

Baseline details

The energy cost in a ceramic unit accounts for 25-30% of total production cost. In ceramic tile unit, spray dryer is second major source of fuel consumption after the roller kiln. Moisture which is added in the grinding process in the ball mill is removed in spray dryers. Hot flue gases at 550–600°C from hot air generator reduces the moisture from 35–40% in input slurry to 5–7% in output slurry.

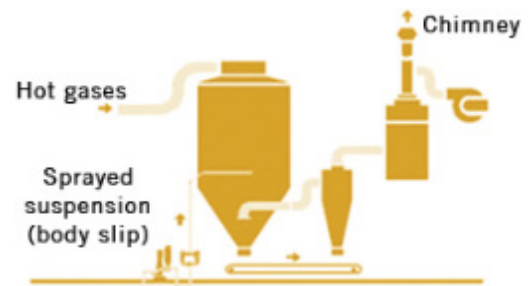

Figure 72: Spray dryer system

Spray dryer has two sections -hot air generator and drying chamber. Lignite and Indonesian coal are used mainly in HAG for generating the hot gases.

Radiation loss accounts for 15% to 20% of total energy loss. Poor surface insulation results in heat loss to surroundings and thereby increasing fuel consumption.

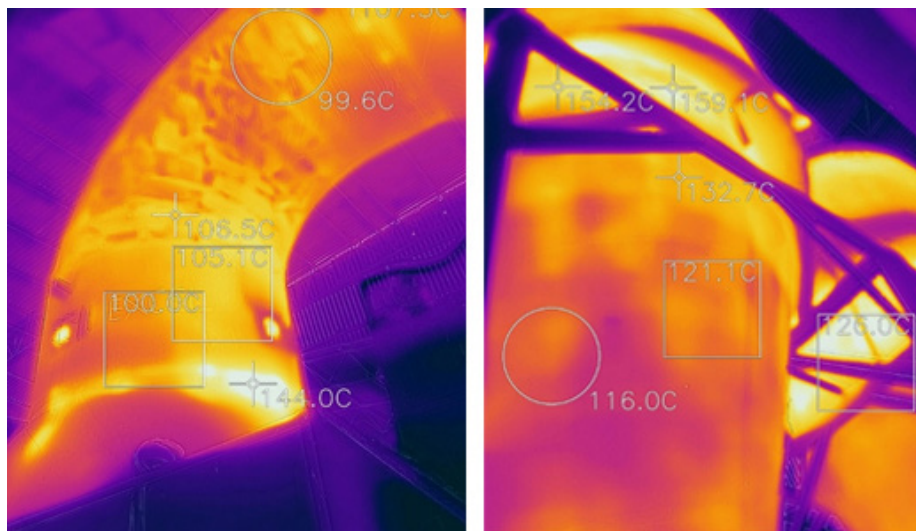

Figure 73: Thermal images of Hot gas generator duct connecting to cyclone separator

Implementation Details

This radiation loss can be reduced by replacing the damaged insulation or by application of new insulation thereby resulting in saving in fuel consumption in hot air generator

Results:

- ❖ Reduced specific energy consumption in unit
- ❖ Increased thermal efficiency of hot air generator

Cost Benefit Analysis

The expected energy savings to be achieved by insulation improvement in HAG is 1,808 Lakh kCal annually. The annual monetary saving for this project is INR 2.63 Lakh, with an investment of INR 4.60 Lakh and a payback period of 21 months.

Table 86: Cost benefit analysis – Insulation improvement in HAG for spray dryer

Parameter	Value	UOM
Diameter of cyclone separator	3	m
Length of cyclone separator	3.5	m
Surface area cyclone separator	33	m ²
Diameter of connecting duct to cyclone separator	2	m
Length of connecting duct to cyclone separator	4	m
Surface area connecting duct to cyclone separator	25.1	m ²
Total surface area	58.1	m ²
Average surface temperature before insulation	110	°C
Proposed average surface temperature after insulation	70	°C
Average coal loss due to high skin temperature before insulation	8.3	kg/h
Proposed average coal loss due to high skin temperature after insulation	3.2	kg/h
Average coal saving	5.1	kg/h
Annual operating hour	8,760	hrs/annum
Annual coal saving	45	Tonne/annum
Cost of coal	5,852	INR/Tonne
Total annual monetary saving	2.63	INR Lakh/annum
Investment	4.60	INR Lakh
Simple payback period	21	Months



Energy & GHG Savings



Technology Supplier Details

Table 87: Technology supplier details – Insulation improvement in HAG

Description	Details
Name of Company	Cumi Morgan Advance Materials
Contact Person	Mr Alpesh Gupta
Designation	Director
Contact	Mobile: +91 9824013885



4.5.8. Excess air control system to maintain optimum air to fuel ratio in Hot air generator (HAG)

Baseline details

The energy cost in a ceramic unit accounts for 25-30% of total production cost. In ceramic tile unit, spray dryer is second major source of fuel consumption after the roller kiln. Moisture which is added in the grinding process in the ball mill is removed in spray dryers. Hot flue gases at 550–600°C from hot air generator reduces the moisture from 35–40% in input slurry to 5–7% in output slurry.

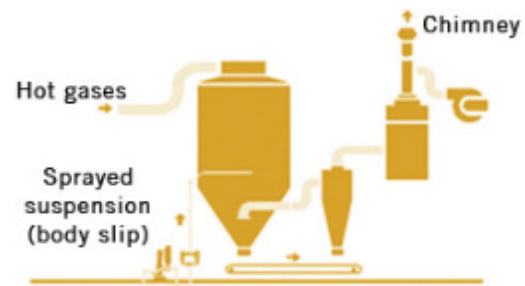

Figure 74: Spray dryer system

Spray dryer has two sections-hot air generator and drying chamber. Lignite and Indonesian coal are used mainly in HAG for generating the hot gases.

Excess air level in the combustion play a vital role in optimizing the fuel consumption and combustion efficiency of HAG firing. The excess air level is calculated based on the amount of oxygen in the exhaust flue gases.

$$\text{Excess air} = (O_2)/(21-O_2) \times 100\%$$

Where O_2 = % oxygen in flue gas

Excess air level in combustion air is to be maintained at optimum level as too much of excess air results in excessive heat loss in exhaust flue gas and maintaining too little excess air results in incomplete combustion and formation of carbon monoxide in flue gases and thus reducing the heat content in the flue gas. If fuel is fired with too much of excess air, this results in formation of excess flue gases, taking away the heat produced from the combustion and increasing the fuel consumption.

Implementation Details

A PID controller, if installed, can measure the oxygen levels in the flue gases at the exit of the HAG and based on that the combustion air flow from FD blower/fan will be regulated. Subsequently, proper temperature and optimum excess air for combustion can be attained in the HAG.

In air flow control system, an O_2 sensor is to be installed in exhaust fuel gas and VFD on combustion air fan. The sensor measures the O_2 & provides the feedback/input to PID controller. The PID controller provide input to the combustion blower (FD fan) VFD to control the speed and thereby control the volume of air to be required for complete combustion with optimum excess air.



Results:

- ❖ Reduced specific energy consumption in unit
- ❖ Increased thermal efficiency of Hot air generator

Cost Benefit Analysis

The expected energy savings to be achieved by by optimizing the excess air in HAG is 32,644 Lakh kCal annually. The annual monetary saving for this project is INR 47.50 Lakh, with an investment of INR 20.00 Lakh and a payback period of 5 months.

Table 88: Cost benefit analysis – Excess air control system in HAG

Parameter	Value	UOM
Oxygen level in flue gas just before firing zone before intervention	14.00	%
Excess air percentage in flue gas before intervention	200	%
Proposed Oxygen level in flue gas just before firing zone after implementation	8	%
Proposed excess air percentage in flue gas	61.5	%
Coal consumption before intervention	977.5	kg/hr
Proposed coal consumption after implementation	842.2	kg/hr
Saving in specific fuel consumption	0.14	Tonne/hr
Operational hours	24	Hours /day
Operational days	300	Days/annum
Annual coal consumption savings	812	Tonne/annum
Cost of coal	5,852	INR/Tonne
Total annual monetary saving	47.5	INR Lakh/annum
Investment	20	INR Lakh
Simple payback period	5	Months



Energy & GHG Savings



Technology Supplier Details

Table 89: Technology supplier details – Excess air control system

Description	Details
	Supplier – 1
Name of Company	Wesman Thermal Engineering
Contact Person	Mr Tushar Shah
Designation	General Manager
Contact	Mobile: +91 9879206992
	Supplier – 2
Name of the company	Tirupati Automation, Morbi
Contact Person	Bhavesh Vamja
Email Id	tirupatiautomation@gmail.com
Phone No	+91-9879411415 , +91-8000682152
Address	Ta.Wankaner, Dist. Morbi (Gujarat)



5. Conclusion

In a typical tile & sanitaryware manufacturing unit, kiln firing and raw material blending operations are dominant energy users. Significant energy efficiency improvement opportunities in units exist in kiln firing and raw material blending via waste heat recovery, thermo ceramic coating to reduce the radiation losses in kiln, low thermal mass in kiln furniture, utilization of renewable energy, high alumina balls in glaze ball mill in the place natural stone/pebbles, high speed blunger in place of ball mill and increased automation. Through this compendium, some of the key technologies that are highly replicable in the cluster have been identified and for these technologies the case examples are included.

The identified technologies can be categorized into three heads, namely, Level 1, Level 2 and Level 3, based on the investment requirement and the payback, as follows:

Level 1: Low investment

- ❖ Waste heat recovery in roller kiln
- ❖ Waste heat recovery in tunnel kiln
- ❖ Reduction in ball mill power by installation of VFD on ball mill drive
- ❖ Installation of VFD in screw compressor to avoid unloading
- ❖ Retrofit energy efficient ceiling fans in place of conventional fans
- ❖ Energy efficient pumps
- ❖ Energy conservation in compressor by modifying airline system
- ❖ Transvector nozzle for compressed air sanitaryware mould cleaning application
- ❖ Maximum demand controller for avoiding excess contract demand penalty
- ❖ Installation of VFD on agitator motor
- ❖ Installation of on-off controller system in agitator motor
- ❖ Installation of energy efficient motor in place of existing conventional motors in agitator system

Level 2: Medium investment

- ❖ High alumina balls in glaze ball mill in the place natural stone/pebbles
- ❖ Energy conservation in compressor by modifying airline system
- ❖ Energy efficient coating to reduce the radiation losses in kiln and reduce fuel consumption



- ❖ Improvement of kiln insulation in roller kiln to reduce radiation losses
- ❖ Excess air control system to maintain optimum air to fuel ratio in kiln
- ❖ Replacement of inefficient centrifugal fans with energy efficient fans in spray dryer
- ❖ Installation screw compressor with VFD in place of reciprocating compressor
- ❖ Retrofit energy efficient motors in place of old rewinded motors
- ❖ Power factor correction & harmonic mitigation at main LT incomer
- ❖ Low thermal mass for reduction of kiln furniture losses in sanitaryware units
- ❖ Implementation of CFD Analysis for improving heat transfer in spray dryer
- ❖ High speed blunger in place of ball mill for raw material grinding process

Level 3: High investment

- ❖ Solar rooftop system
- ❖ Solar-wind hybrid system
- ❖ Hydroxy gas combustion in kiln firing in roller kiln
- ❖ Installation of Energy Efficient burners in place of existing old conventional burners in kiln firing
- ❖ Optimization of water consumption by installation of water softener unit
- ❖ Installation of Energy Management System
- ❖ Insulation improvement in Hot air generator for spray dryer
- ❖ Excess air control system to maintain optimum air to fuel ratio in Hot air generator (HAG)

The energy efficiency & renewable energy projects detailed in the case studies in this compendium indicate that there is a good potential for benefits in both low hanging and medium-to-high investment options. The ceramic units in Morbi can implement the low hanging fruits (with smaller investments) faster, as with minimum or no investments, several savings can be achieved. However, for the high investment projects, a detailed review in the form of DPR can be prepared.

The Morbi ceramic cluster should view this manual positively and utilize this opportunity to implement the best operating practices and energy saving ideas during design and operation stages and thus move towards achieving world class energy efficiency.



This Page Intentionally Left Blank



For more details, please contact



**UNITED NATIONS
INDUSTRIAL DEVELOPMENT ORGANIZATION**

Vienna International Centre
P.O. Box 300 · 1400
Vienna · Austria
Tel.: (+43-1) 26026-0
ENE@unido.org
www.unido.org

UNIDO
Regional office in India
UN House
55 - Lodi Estate,
New Delhi-110 003, India
office.india@unido.org



Bureau of Energy Efficiency
Government of India, Ministry of Power

4th Floor, Sewa Bhawan,
R. K. Puram,
New Delhi - 110 066
India
Tel.: (+91) 011 2617 9699-0
gubpmu@beenet.in
www.beeindia.gov.in